

THE WAY FOR ENERGY

HALOGEN-FREE, LOW SMOKE
AND FIRE RESISTANT CABLES

TF
Kable

Table of Contents

FIRE SAFETY	002	FIRE RESISTANT, FLAME RETARDANT, HALOGEN FREE, LOW SMOKE DATA CABLES	124
BUSINESS POLICY	004	FLAME-X 950 JE-H(St)H...Bd FE180/E90	126
OUR HISTORY	006	FlameBlocker JE-H(St)H...Bd	128
PRODUCTION POTENCIAL	008	FlameBlocker J-H(St)H...Bd	130
QUALITY	010	FlameBlocker LiHH, LiHCH	132
DISTRIBUTION	012	OFFSHORE/MARINE CABLES	134
LEADING STANDARDS, TESTING AND REGULATIONS	014	FLAME-X 950 NKOgs 0,6/1 kV	136
FIRE RESISTANT, FLAME RETARDANT, HALOGEN FREE, LOW SMOKE CABLES AND WIRES	020	FLAME-X 950 NKOgsekw 0,6/1 kV	139
FLAME-X 950 (N)HXH FE180/E30 0,6/1 kV	022	FlameBlocker NKOXS 0,6/1 kV	142
FLAME-X 950 (N)HXH FE180/E90 0,6/1 kV	026	FlameBlocker NKOXSekw 0,6/1 kV	145
FLAME-X 950 NHXH FE180/E30 0,6/1 kV	030	DATA MATRIX	148
FLAME-X 950 NHXH FE180/E90 0,6/1 kV	033	CONSTRUCTION	148
FLAME-X 950 (N)HXCH FE180/E30 0,6/1 kV	036	FIRE PERFORMANCE	150
FLAME-X 950 (N)HXCH FE180/E90 0,6/1 kV	039		
FLAME-X 950 NHXCH FE180/E30 0,6/1 kV	042		
FLAME-X 950 NHXCH FE180/E90 0,6/1 kV	045		
FLAME-X 950 Standard 300/500V	049		
FLAME-X 950 Enhanced 300/500V	051		
FLAME-X 950 Power 0.6/1 kV	053		
FLAME-X 950 Single 0.6/1 kV	056		
FLAME-X 950 FR Flex 3013 0.6/1 kV	059		
FLAME-X 950 CR1-C1 300/500V	063		
FLAME-X 950 HDGs, HLGs, HLgGs, HDGsekwf, HLGsekwf, HLgGsekwf 300/500V	066		
FLAME RETARDANT, LOW FIRE HAZARD, HALOGEN FREE, LOW SMOKE CABLES AND WIRES	070		
FlameBlocker N2XH 0,6/1 kV	072		
FlameBlocker (N)2XH FE180 0,6/1 kV	077		
FlameBlocker N2XCH 0,6/1 kV	079		
FlameBlocker (N)2XCH FE180 0,6/1 kV	081		
FlameBlocker NHXMH 300/500V	084		
FlameBlocker (N)HXMH(St) 300/500V	086		
FlameBlocker H07Z-U, H07Z-R, H07Z-K 450/750V	089		
FlameBlocker H07ZZ-F 450/750V	091		
FlameBlocker H05Z1Z1-F 300/500V	094		
FlameBlocker UK REF. 6181B 450/750V	096		
FlameBlocker UK REF. 6181 XB XLPE/LSF 0,6/1 kV	098		
FlameBlocker UK REF. 624(*)B 300/500V	099		
FlameBlocker UK REF. 318(*)B 300/500V	101		
FlameBlocker FR-N1X1G1-U 0,6/1 kV	103		
FlameBlocker CU/XLPE/LSOH/AWA/LSOH			
FlameBlocker CU/XLPE/LSOH/SWA/LSOH 0,6/1kV	105		
FlameBlocker MMJ HF 450/750 V	109		
FlameBlocker EQQ LIGHT 300/500 V	111		
FlameBlocker EXQJ 0,6/1 kV	113		
FlameBlocker FXQJ 0,6/1 kV	115		
FlameBlocker AXQJ 0,6/1 kV	117		
FlameBlocker NSHXAFÖU 1,8/3 kV	120		
FlameBlocker NSHXAFÖU POWER CABLE 3,6/6 kV	122		

FIRE SAFETY

There would be no contemporary civilization without fire. It has been discovered and coexists with human being since ages. On the one hand it provides great support, but on the other it carries enormous risk. In the last century due to the formation of large human settlements and changing the nature of development, the possibility of fire has increased. A factor in its development is often the material used to build houses, insecure use, and lack of appropriate alarm systems and quick response safety systems.

Only in 2006 in 37 selected countries for the population of 3.62 billion (55% of the world's population) were registered a total of up to 4 143 913 fires in which 42,291 people have been killed (source: CTIF 2008 - The international association of fire and rescue services). It is also estimated that the direct and indirect costs of all fires, including the economic impact of killed and wounded people, are nearly 1% of global GDP.

In Europe, each day after a fire 12 people on average are killed, and about 120 are seriously injured. Total economic losses are estimated at around 25 billion Euros per year (source: European Flame Retardants Association).

The most dangerous fires in respect of consequences are buildings fire events, mainly these within an urban agglomeration. This applies to places with high population density and points of interest such as:

- » Hospitals
- » Schools,
- » Shopping malls
- » Office buildings
- » Tunnels
- » Stadiums
- » Airports
- » Industrial sites.

Most fire hazards are created in these facilities due to a short circuit in electrical wiring, gas explosion or setting a fire by an accident. In these places a fire brigade intervenes most often.

There is number of tragic fires, where in recent years, the lack of adequate security system has caused loss of life and enormous material destruction.

Modern technologies used in construction involve the use of materials with improved fire resistance. If a fire occurs, the materials of which are built various structures and fire protection systems should enable people to safely evacuate, and quick extinguishing of the fire.

In the interest of public safety, the authorities on almost every level, pay attention to this aspect, which is reflected in the standards and EU directives and national regulations as well as local legislation.

Cables in the event of fire

The fire itself not only carries the risk of fire spread, but also the danger of the spread of smoke and toxic substances extremely hazardous to human life. Currently, the primary material used in the production of power cables, signal cables, control and measurement, and telecommunications is PVC - Polyvinyl chloride.

It is in several respects an ideal material for the manufacture of cables. Its mechanical properties combined with high reliability offer great opportunities for cable industry. However, in reaction to fire this polymer creates a huge risk. Fires in which the PVC is combusted are characterized by emission of large quantities of smoke, soot and toxic, corrosive substances. Already at the temperature of 120°C PVC releases hydrogen chloride (HCl) and dioxins and furans (PCDD and PCDF) - one of the most harmful substances recognized by toxicology.

The resulting large quantities of black smoke, toxic, corrosive gases and acids disable effective evacuation and greatly hinder the carrying out rescue operations.

To meet these dangers, Tele-Fonika Kable systematically develops range of alternative products manufactured



from halogen-free materials, materials made incombustible and fireproof.

Despite of the fact that the phenomenon of fire caused by the cables themselves is unheard, so very often happens the case that the fire covers the places where the cables are installed. In these extreme circumstances, it is expected that for some time there has been no interruption in energy supply, no interruption of signal for alarm points and devices, fire protection devices and devices complying with a key role in the safe evacuation.

The use of cables maintaining the circuit integrity during the fire, not emitting smoke and poisonous gases is a key issue not only for us as a producer, but for users of cable or alarm systems, both regarding to the personal safety of people and to protect equipment and property.

Security of cable routes

Safety and efficacy of the electrical installation in a fire depends on the type of cables used and the method of mounting and conducting the cable routes.

Currently, there is still no common European standard that specifies test methods throughout the entire cable route, so as binding rules are adopted the rules of research and classification according to German DIN 4102-12. This standard specifies requirements for fire testing of cables and systems for conducting with a common classification of E30 (keeping the system functions for 30 minutes in a fire) and E90 (keeping the system functions for 90 minutes in a fire).

Observation of phenomena occurring during the fire tests can unequivocally state that electrical installations are safe only if the correct choice of cable elements and strict adherence to the recommendations of manufacturers of cable systems are kept.

The continuity of energy supply and signal is determined equally by quality of used cables and other components, and by the method of cables installation.

To ensure the implementation of a comprehensive solution for safe installation, Tele-Fonika Kable has performed fire tests of its cables together with the best producers of cable elements.

TELE-FONIKA Kable

The Group TELE-FONIKA Kable (TF Kable) is ranked in the forefront of the global cable industry. The Group is the third manufacturer of cables and wires in Europe with significant development potential, based entirely on Polish capital.

TELE-FONIKA Kable Group's considerable investment in research and development centers and multi-skilled work teams, which have included eminent scientists working with our specialists, has been rewarded by the introduction of new-generation products and comprehensive services in the field of cable engineering. Products manufactured in our plants are sold in over 90 countries. Our product assortment includes 25 thousand cable types. The highest quality of our products is confirmed by over 460 certificates for groups of wares licensed by 34 renown centres of certifications worldwide. The company combines the good traditions of the cable industry in Poland and innovative technical solutions. TELE-FONIKA Kable Group consists of seven plants — five in Poland, one in Ukraine, and one in Serbia. We own over a dozen trade agencies abroad, reaching customers in several dozen countries around the world.

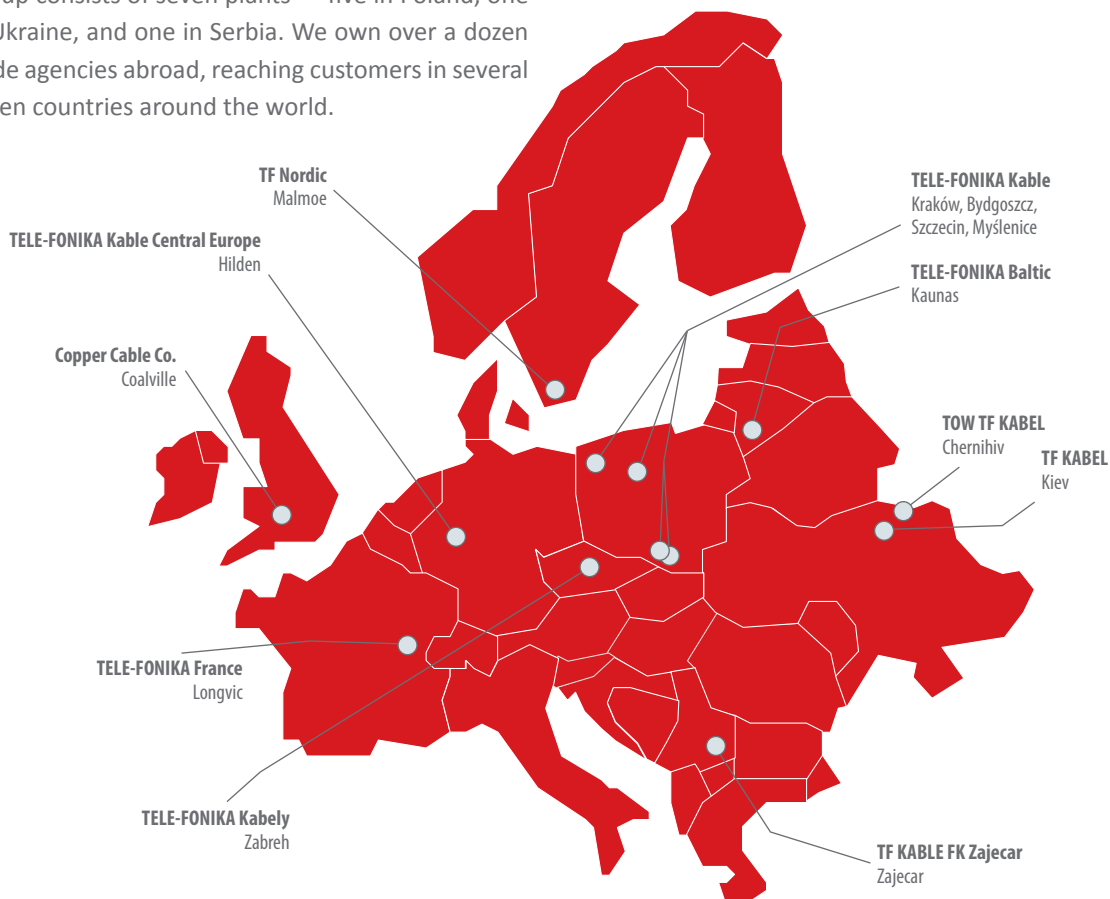

We deliver
reliability

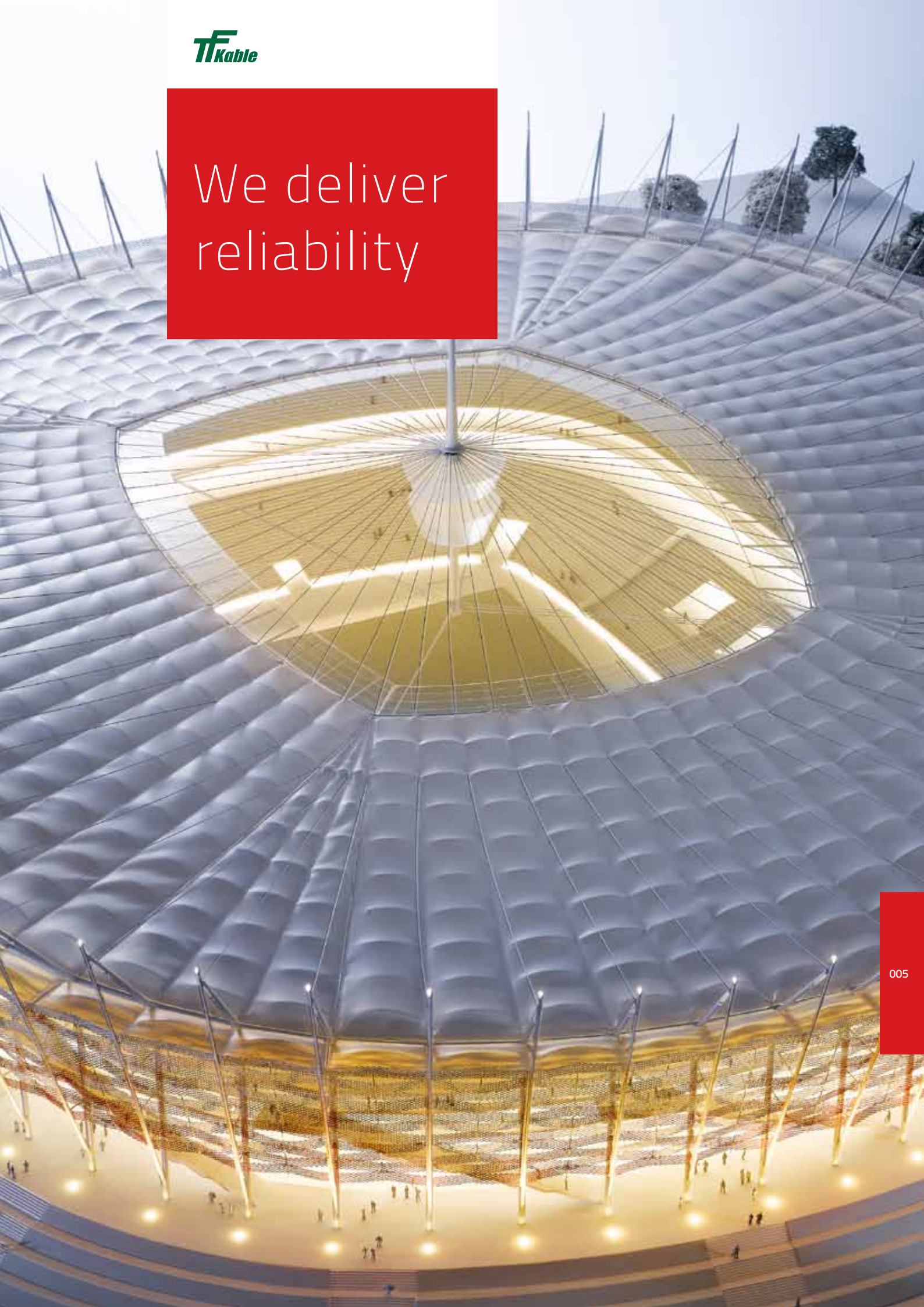

PRODUCTION POTENTIAL

Our chief asset is extensive technological know-how in the field of production of wide variety of cables and wires supported by our experienced personnel. Our products match to a great extent the general trends concerning ecology and maintenance safety of wares. Extremely strict legislation in these areas has become the indicator of the technological progress of the manufactured cables.

Kraków-Wielicka Plant

Kraków-Wielicka Plant was established in 1928. In 1992 it received the ISO 9002 certificate (now ISO 9001) and in 1998 the ISO 14001 given by the British certification body: BASEC. The plant specializes in the production of rubber insulated cables and wires for mining and industrial applications. All types of rubber mixes used for EPR, CR, EVA and CSP cables are based on an original prescription designed together with research and development centres. The production offer of the plant are also medium voltage cables made in XLPE technology, as well as signal and control wires for special purposes.

Kraków-Bieżanów Plant

Kraków-Bieżanów Plant was established in 2001. In 2002 it received the ISO 9001 certificate and 14001 given by the British certification body: BASEC. The plant specializes in the production of overhead conductors from alloyed aluminium, conductors for railway traction network from copper and its alloys and installation wires for general usage.

Bydgoszcz Plant

Bydgoszcz Plant started production of cables and wires back in 1923. In 1992 it received the ISO 9002 certificate (now ISO 9001) and in 1998 the ISO 14001 given by the British certification body: BASEC. Bydgoszcz Plant specializes in power supply cables of medium and high voltage up to 400 kV. It is equipped with six modern chain lines for crosslinking polyethylene in XLPE technology. Complementary technological lines for producing the abovementioned cables ranging from thick wire drawing machines, cable stranding machines and screening machines to covering lines and two large-size high voltage laboratories called "Faraday cage" place the plant in the top of the list of the largest production centres of medium and high voltage cables in Europe.

Myślenice Plant

Myślenice Plant was established in April 1992 under the name Zakłady Kablowe TELE-FONIKA s.c. In 1995 it received the ISO 9001 certificate and in 1999 the ISO 14001 certificate. The certification body is BASEC. In September 2007 the plant received the ISO/TS 16949 certificate for automotive cables given by the certification body: SGS. Myślenice Plant specializes in the production of copper and fibre optic telecommunication cables, computer cables and automotive wires.

Szczecin Plant

Szczecin Plant was established in 1958. In 1992 it received the ISO 9002 certificate (now ISO 9001) and in 1998 the ISO 14001 given by the British certification body: BASEC. This Plant is also certified according to ISO/TS 16949 by SGS. It specializes in production of enamelled magnet wires.

TOW TF Kabel (Ukraine)

The plant was established in 2002. In 2007 the plant was joined into the TELE-FONIKA Kable Group. This Plant is certified according to ISO 9001 and 14001. It specializes in the production of overhead conductors and cables for voltage up to 1 kV, including halogen-free, fire resistant and flame retardant cables versions.

TF Kable Fabrika Kablova Zajecar A.D. (Serbia)

The plant was established in 1974. In 2007 the plant was joined into the TELE-FONIKA Kable Group. This plant is certified according to ISO 9001 and 14001 by DAS Certification Ltd. It specializes in the production of low and medium voltage cables, as well as halogen-free, fire resistant and flame retardant cables, telecommunication cables and PVC and polyethylene-coated conductors.

A low-angle photograph of several white wind turbines in a field, set against a bright blue sky with scattered white clouds. The turbines are arranged in a line, receding into the distance. The foreground shows the dark, textured ground of the turbine bases.

Experience and innovation

LEADING STANDARDS, TESTING AND REGULATIONS

Fire-resistant cables, also known as safety cables or function cables are widely used in the building and construction industry as part of a fire protection systems. Like any other halogen-free cables HFFR-type, these cables are also characterized by limited flame spread during the fire and reduced smoke emissions (especially corrosive gases). However, their crucial role in the fire safety system is to maintain circuit integrity during a fire, within a specified period of time.

On the basis of the experience arising from research which have been implemented over the behaviour of the cables at the time of the fire and security-related research related to fire safety in buildings, there was developed a number of national and international standards for the construction of cables and determining the way of their testing and acceptance criteria.

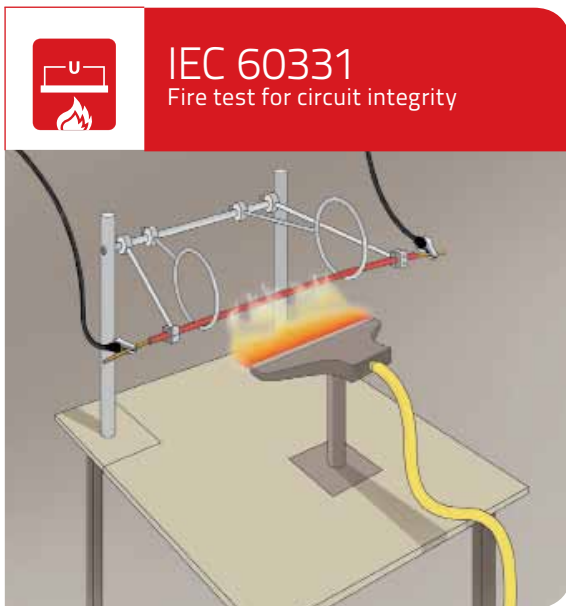

IEC 60331
Fire test for circuit integrity

IEC 60331-23

Tests for Electric Cables under Fire Conditions - Circuit Integrity. Procedures and Requirements - Electric Data Cables

IEC 60331-25

Tests for Electric Cables under Fire Conditions - Circuit Integrity - Part 25: Procedures and Requirements - Optical Fibre Cables

IEC 60331-31

Test for electric cables under fire conditions and shock-Circuit integrity. Procedures and requirements for Fire with Shock - Cables of rated voltage up to and including 0.6 / 1 kV

TEST DESCRIPTION

Part 60331-21. A sample of the cable length of 1200 mm sustained by two metal rings is mounted horizontally in a special ventilated cabin. During the test, to the wire cores of cable a voltage of the nominal value is applied (for telecommunication cables equal to 110 V), thereby creating a closed electric circuit. The sample is subjected to an action of linear gas burner with a length of 500 mm and the flame temperature equal to 750 ° C till 800 ° C. The time of the fire is 180 minutes. Result of the test is considered positive if at that time will not be considered a short circuit in the circuit being researched.

Part 60331-31 applies to the cables with a diameter greater than 20mm², and introduces the standards and

IEC 60331-11

Apparatus - Fire alone at a temperature of flame of at least 750 ° C

IEC 60331-12

Apparatus - Fire with shock at a flame temperature of at least 830 ° C

IEC 60331-21

Test for electric cables under fire conditions - Circuit integrity. Procedures and requirements - Cables of rated voltage up to and including 0.6 / 1 kV

procedures for testing of cables exposed to fire and mechanical shock (equipment according to 60331-12).

The test sample provides cable fragment length at least 1500 mm. Bent wire on the U-shaped with a radius equal to the smallest permissible by the manufacturer, is mounted on a metal assay ladder. During the study,

through all the cable wires is passed current with rated voltage and these cables are subjected to fire during 120 min, where fire source is a gas burner set in conformity with standards, as well the mechanical shock of the 5 minutes interval. Result of the test is considered positive if at that time will not be considered a short circuit in the circuit being tested.

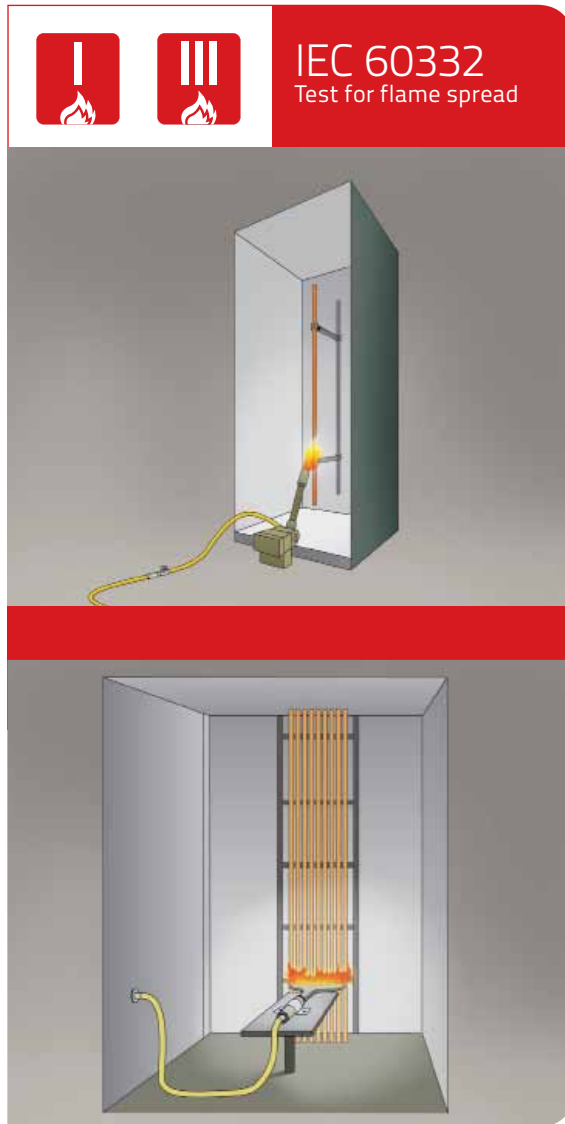

IEC 60332-1-2

Tests on electric and optical fibre cables under fire conditions Part 1-2: Test for vertical flame spread for a single insulated wire or cable Procedure for 1 kW pre-mixed flame

IEC 60332-2-1

Tests on electric and optical fibre cables under fire conditions Part 2-1: Test for vertical flame spread for a single small insulated wire or cable. Apparatus

IEC 60332-2-2

Tests on electric and optical fibre cables under fire conditions Part 2-2: Test for vertical flame spread for a single small insulated wire or cable Procedure for diffusion flame

IEC 60332-3-10

Tests on electric and optical fibre cables under fire conditions - Part 3-10: Test for vertical flame spread of vertically-mounted bunched wires or cables Apparatus

IEC 60332-3-21

Tests on Electric Cables Under Fire Conditions - Part 3-21: Test for Vertical Flame Spread of Vertically-Mounted Bunched Wires or Cables - Category A F/R

IEC 60332-3-22

Tests on electric and optical fibre cables under fire conditions - Part 3-22: Test for vertical flame spread of vertically-mounted bunched wires or cables - Category A

IEC 60332-3-23

Tests on electric and optical fibre cables under fire conditions - Part 3-23: Test for vertical flame spread of vertically-mounted bunched wires or cables - Category B

IEC 60332-3-24

Tests on electric and optical fibre cables under fire conditions - Part 3-24: Test for vertical flame spread of vertically-mounted bunched wires or cables - Category C

IEC 60332-3-25

Tests on electric and optical fibre cables under fire conditions - Part 3-25: Test for vertical flame spread of vertically-mounted bunched wires or cables - Category D

TEST DESCRIPTION

Part 1 (IEC 60332-1)

Flame spread test on single cable

A cable sample provides an isolated section of cable with a length of 600 mm placed in a metal enclosure, open in front. To sample shall be applied at an angle the

source of fire produced by a burner powered by technical propane (95% nominal purity).

The burner should be set at 45 degrees so that the tip of the internal cone of blue flame touches the sample at a distance of 475 mm from the bottom of the upper bracket.

Time of application of the flame depends on the diameter of the tested sample. After completion of the test burner must be removed, and extinguish the flame.

If after removal of the fire source will not be visible charring or other damages on a distance of not less than 50 cm from the bottom edge of the upper clamp, the result of test is therefore considered positive.

Part 3 (IEC 60332-3)

Flame spread test on a bundle of cables

To vertical ladder affixed in adapted chamber is fasten a certain number of cable sections with a length of

3.5 m. The amount of combustible materials for cables and duration of flame application depends on the category the cable has to meet.

Category A

7 litres/m of combustible materials for cables
- the time of application of the flame 40 min

Category B

3.5 litres/m of combustible materials for cables
- the time of application of the flame 40 min

Category C

1.5 litres/m of combustible materials for cables
- the time of application of the flame 20 min

Resistance of the wires bundle arranged vertically to the spread of the flame should be such that after a certain time and stopping the source of ignition, flame was extinguished by itself and the length of charred fragments did not exceed 2.5 m in height measured above the lower edge of the burner.



IEC 61034-1

Measurement of Smoke Density of Cables Burning Under Defined Conditions - Part 1: Test Apparatus

IEC 61034-2

Measurement of smoke density of cables burning under defined conditions - Part 2: Test procedure and requirements

TEST DESCRIPTION

The cable sections are burned in a special cabin in the shape of a cube measuring 3x3x3m with installed on opposite walls the photometric measuring system 100W light source placed at a height of 2.15 m. Photometric measuring system registers the light transmission in the cabin. The result is considered positive if the light trans-
lucency after testing is not less than 60%



IEC 60754

Gases emission test

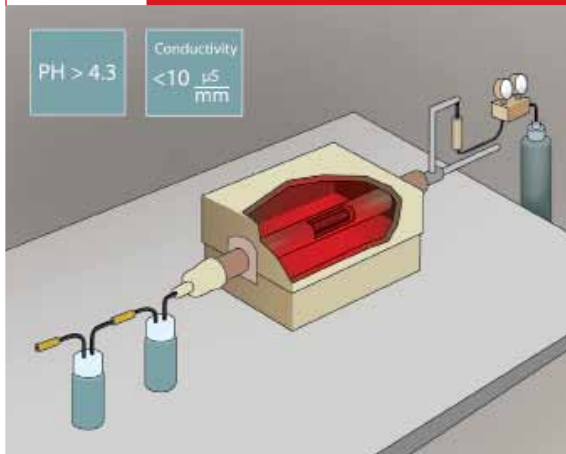

IEC 60754-1

Test on Gases Evolved During Combustion of Materials from Cables - Part 1: Determination of the Amount of Halogen Acid Gas

IEC 60754-2

Test on Gases Evolved During Combustion of Electric Cables, Part 2: Determination of Degree of Acidity of Gases Evolved During the Combustion of Materials Taken from Electric Cables by Measuring pH and Conductivity

TEST DESCRIPTION

Part 1

Small (1 g) fragmented sample is placed in a quartz tube and gradually heated in the tube furnace to 800 ° C and then maintained at this temperature for 20 minutes. Into

the pipe shall be blown an air of a certain flow rate, which, after leaving the tube, is guided to the scrubbers. For aqueous solutions of gases evolved during combustion of the material sample and collected in the scrubbers the halogen acid content is estimated on the basis of analytical method. The test result is considered positive if the acid content is less than 0.5%.

Part 2

The test is performed at least on 1 gram of sample of insulation material and outer coating and any other non-metallic substances in the cable. Furnace is heated to a temperature of 935 ° C min, after which it is placed in a quartz tube with a sample of the material inside. Certain amount of non-metallic substances of cable is burnt in the tube furnace for approximately 30 minutes. The resulting gases are guided by air blow-trough to scrubbers with distilled water. Solutions obtained in this way are measured in respect of acidity (pH) and conductivity. The test result is considered positive if the pH acidity of the solutions is less than 4.3 and the conductivity is not greater than 10 mS/mm.

The test apparatus consists of the following devices:

- Place of burning of approximately 170 mm length
- Air flow meter
- Two bottles, to which released gas is drained, including one bottle with two entered electrodes.
- Gas from cylinder synthetic air
- PH Meter
- Conductivity meter

EN-50200

Test for resistance to fire

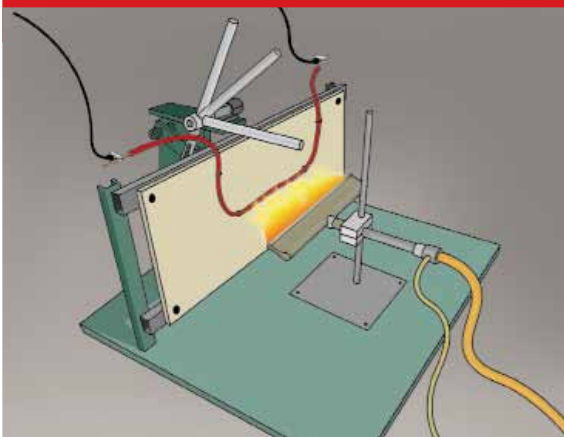

TEST DESCRIPTION

In the adapted chamber is mounted a cable sample with a length of 1200 mm, to which wire cores during the test a nominal value voltage is applied, creating thereby a closed circuit. During the test the cable is subjected to actions of the fire at conventional temperature 842 ° C and mechanical stroke for a specified period of time. The measured time of proper functioning of the cable corresponds to the so-called cable fire resistance class PH, which is also mentioned in the standard PN-B-02851-1 - Fire resistance tests of elements of buildings (Test method for thin wires with an outside diameter not greater than 20 mm).

- PH 15 - 15 min
- PH 30 - 30 min
- PH 60 - 60 min
- PH 90 - 90 min
- PH 120 - 120 min



DIN 4102-12

Cable system integrity test

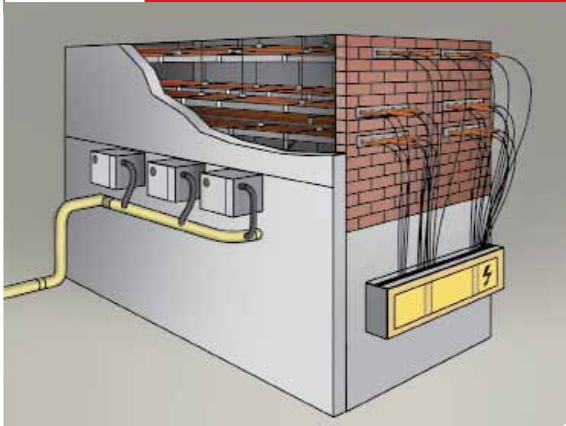

Maintaining the function of electrical cable during the fire, defined as the concept of cable systems is characterized by the German DIN 4102, part 12.

This is one of the most rigorous criteria for cables that in the best way simulates the actual conditions prevailing during the fire.

The test stand has dimensions 2m/3m/2.5 (width/length/height) and meets the standard DIN 4102-2.

The minimum length of the sample should be 3 m.

Classes of functions maintenance according to DIN 4102-12

E30 - cable system function maintenance in case of fire for 30 minutes

E60 - cable system function maintenance in case of fire for 60 minutes

E90 - cable system function maintenance in case of fire for 90 minutes

TEST DESCRIPTION

The test conditions described in this standard shall be considered as the most rigorous as it was yet discussed, but on the other hand, as most closely related to real fire conditions. The standard defines testing the functionality of so-called cable set, which consists of a group set of power cables, telecommunications, data transfer, etc. to be installed in real conditions, fixed to the provided to apply support structure consisting of channels, ladders, items to hang, handles, etc. Cables attached to this structure are powered by their work voltage, and when testing can arise neither short-circuit of insulation nor break the continuity of any wire core. The classification of cable set as a whole to one of three classes determines the duration of the cables operation in temperature provided at test conditions: Class E30 - 30 minutes at 820 °C, the class E60 - 60 minutes at 870 °C, the class E90 - 90 minutes at 980 °C. It is worth noting that duration of the cable operation under test is determined not only by design and selection of used cable materials, but also and often primarily, the construction and selection of supporting structure materials, which is subject to deformation in high temperatures, and these deformations in turn tighten the cables attached to the structure.

BS 6387 Category C

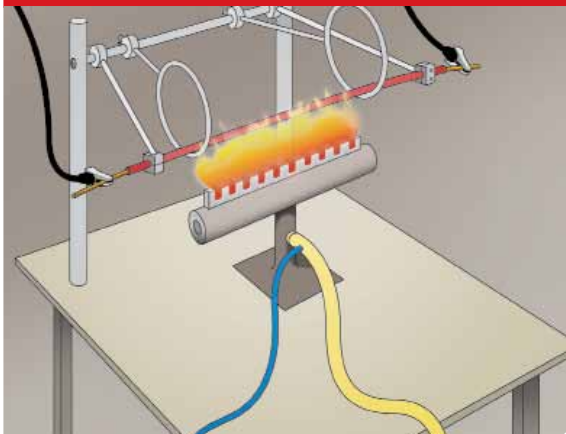

1. Fire resistance test is a test in which the cable is exposed to the fire of a strictly defined temperature in a specific time. The study provides the basis for four categories:

Category A

the cable sample is burned at a temperature of 650 °C for 3 hours

Category B

the cable sample is burned at a temperature of 750 °C for 3 hours

Category C

cable sample is burned at 950 °C for 3 hours

Category S

cable sample is burned at 950 °C for 20 minutes

TEST DESCRIPTION

Cables test according to standard BS 6387 is carried out in three stages:

1. Fire resistance test cat. C
2. Testing for fire and water resistance cat. W
3. Testing for fire resistance and mechanical stroke cat. Z

BS 6387 Category W

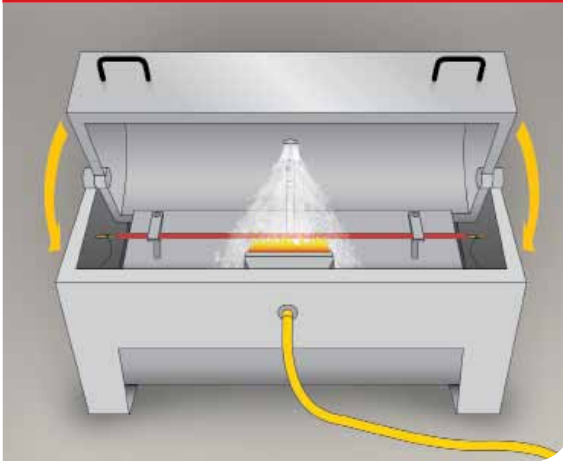

2. Testing for resistance to fire and water - Category W - is a study in which the cable is exposed to a fire at a temperature of 650 °C for 15 minutes and then for another 15 minutes to fire with water that is poured over the area around the cable.

BS 6387 Category Z

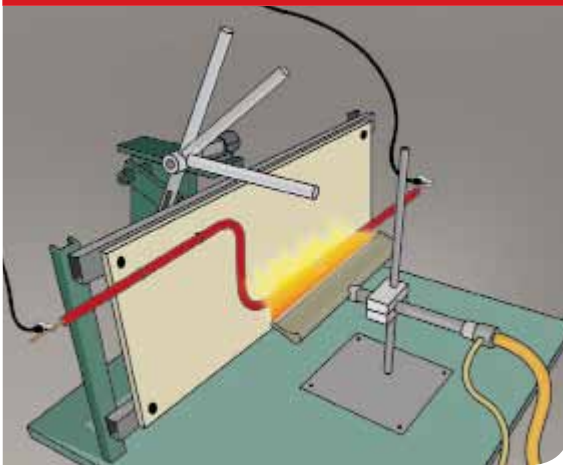

3. Testing for resistance to fire and mechanical stroke - a study in which the cable is exposed to a fire at a specified temperature with a mechanical stroke. The test takes 15 minutes. The test provides a basis to distinguish three categories:

Category X - the cable sample is burned at a temperature of 650 °C and subjected to mechanical shock

Category Y - cable sample is burned at a temperature of 750 °C and subjected to mechanical shock

Category Z - cable sample is burned at 950 °C and subjected to mechanical shock



Safe way for energy



FLAME-X⁹⁵⁰

CHAPTER 1

FLAME-X 950 (N)HXH FE180/E30 0,6/1 kV	22	FLAME-X 950 Standard 300/500V	49
FLAME-X 950 (N)HXH FE180/E90 0,6/1 kV	26	FLAME-X 950 Enhanced 300/500V	51
FLAME-X 950 NHXH FE180/E30 0,6/1 kV	30	FLAME-X 950 Power 0,6/1kV	53
FLAME-X 950 NHXH FE180/E90 0,6/1 kV	33	FLAME-X 950 Single 0,6/1kV	56
FLAME-X 950 (N)HXCH FE180/E30 0,6/1 kV	36	FLAME-X 950 FR Flex 3013 0.6/1 kV	59
FLAME-X 950 (N)HXCH FE180/E90 0,6/1 kV	39	FLAME-X 950 CR1-C1 300/500V	63
FLAME-X 950 NHXCH FE180/E30 0,6/1 kV	42	FLAME-X 950 HDGs, HLGs, HLgGs, HDGsekwf	
FLAME-X 950 NHXCH FE180/E90 0,6/1 kV	45	HLGsekwf, HLgGsekwf 300/500V	66

Fire Resistant, Flame Retardant, Halogen Free, Low Smoke Cables and Wires

Cables are manufactured with the use of halogen-free materials. These materials exhibit better fire performance, have improved resistance to flame propagation and can extinguish flame spread through the cable.

Application:

Halogen-free cables are used for applications in public buildings, where fire would present a significant hazard to human life as a result of emission of toxic gasses and dense smoke hampering the evacuation or when the losses caused by the corrosive acid gasses would be higher than other damage caused by fire.

Locations of increased fire safety requirements, where large agglomeration of people and cultural or material goods of high value are present: schools, hospitals, shopping centers, airports, hotels, supermarkets, underground tunnels, multi-storey buildings, stations of underground railways, underground garages, sports and show halls, stadiums, cinemas, theatres, museums, office buildings, educational centers, industrial complexes.

Tested and approved by:

VDE (Verband der Elektrotechnik)

BASEC (British Approvals Service For Cables)

BBJ (Biuro Badawcze ds. Jakości) - Znak Bezpieczeństwa „B”

GOST (Госстандарт)

Halogen-free low
smoke fire resistant
security power cables

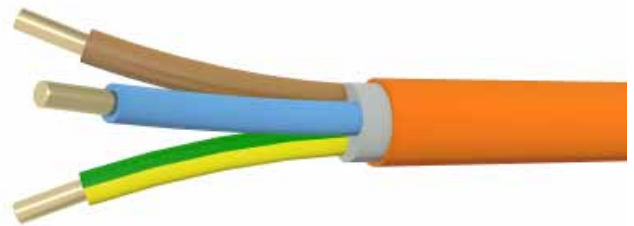

FIRE PERFORMANCE

Insulation integrity FE 180:	DIN VDE 0472-814 (800°C, 180 min.), IEC 60331-21
System integrity E30:	DIN 4102-12 (30 min.)
Flame propagation:	DIN EN 50266-2-2, VDE 0482-266-2-2, IEC 60332-3-22
Smoke density:	DIN EN 61034-2, VDE 0482-1034-2, IEC 61034-2
Gases evolved during combustion:	DIN EN 50267-2-2, VDE 0482-267-2-2, IEC 60754-2: pH ≥ 4,3; conductivity ≤ 2,5 μS/mm

CONSTRUCTION

Conductors:	bare copper conductor, circular solid class 1 (RE) or stranded circular or circular compacted class 2 (RM) according to EN 60228
Insulation:	special cross-linked halogen-free fire resistant silicone compound
Inner covering:	special flame-retardant and halogen-free compound
Sheath:	thermoplastic halogen-free compound type HM4 according to DIN VDE 0276-604
Colour of sheath:	orange

CHARACTERISTIC

Core identification:	according to DIN VDE 0293-308, HD 308 S2 or EN 50334
-----------------------------	--

	(N)HXH-OFE180/E30	(N)HXH-J FE180/E30
	without protective conductor	with protective conductor
1-core:	black	green-yellow
2-core:	blue, brown	—
3-core:	brown, black, grey	green-yellow, blue, brown
3 core:*	blue, brown, black	—
4-core:	blue, brown, black, grey	green-yellow, brown, black, grey
4-core:*	—	green-yellow, blue, brown, black
5-core:	blue, brown, black, grey, black	green-yellow, blue, brown, black, grey
more 5-core:	black with numbering	green-yellow, others cores black with numbering

* For certain applications only.

Maximum conductor operating temperature:	+90°C
Lowest ambient temperature for fixed installation:	-30°C
Lowest installation temperature:	-5°C
Maximum short-circuit conductor temperature:	+250°C
Minimum bending radius:	15D - for single core cable; 12D - for multicore cable (D - overall cable diameter)
Maximum permissible tensile stress with cable grip for Cu-conductor:	50 N/mm ²
Application:	Fire resistant security cables for installation everywhere where high safety requirements have a special significance e.g., in industrial complexes, power stations, public buildings, hotels, underground railway systems, hospitals etc.
Standard packing:	500 m on drums. Other forms of packing and delivery are available on request.

Number and cross-sectional area of conductor			Approximate overall diameter	Approximate net weight of cables	Maximum conductor resistance at 20°C
n x mm ²			mm	kg/km	W/km
1	x	1,5 RE	6,4	57	12,1
1	x	2,5 RE	6,7	69	7,41
1	x	4 RE	7,2	87	4,61
1	x	6 RE	7,7	109	3,08
1	x	10 RE	8,5	152	1,83
1	x	16 RM	9,8	219	1,15
1	x	25 RM	11,5	323	0,727
1	x	35 RM	12,6	420	0,524
1	x	50 RM	14,5	561	0,387
1	x	70 RM	15,8	761	0,268
1	x	95 RM	18,4	1041	0,193
1	x	120 RM	20,0	1285	0,153
1	x	150 RM	22,0	1570	0,124
1	x	185 RM	24,1	1946	0,0991
1	x	240 RM	27,2	2511	0,0754
1	x	300 RM	29,6	3118	0,0601
2	x	1,5 RE	11,5	184	12,1
2	x	2,5 RE	12,3	221	7,41
2	x	4 RE	13,2	272	4,61
2	x	6 RE	14,2	333	3,08
2	x	10 RE	15,8	451	1,83
2	x	16 RM	18,4	646	1,15
2	x	25 RM	22,0	959	0,727
3	x	1,5 RE	12,1	207	12,1
3	x	2,5 RE	12,9	252	7,41
3	x	4 RE	13,9	316	4,61
3	x	6 RE	14,9	394	3,08
3	x	10 RE	16,6	545	1,83
3	x	16 RM	19,7	805	1,15
3	x	25 RM	23,3	1187	0,727
3	x	35 RM	25,6	1530	0,524
3	x	50 RM	29,9	2074	0,387
3	x	70 RM	33,2	2798	0,268
3	x	95 RM	38,5	3808	0,193
3	x	120 RM	41,7	4651	0,153
3	x	150 RM	46,7	5766	0,124
3	x	185 RM	51,0	7086	0,0991
3	x	240 RM	57,8	9168	0,0754
4	x	1,5 RE	13,0	242	12,1
4	x	2,5 RE	13,9	298	7,41
4	x	4 RE	15,0	378	4,61
4	x	6 RE	16,2	478	3,08
4	x	10 RE	18,3	681	1,83
4	x	16 RM	21,5	996	1,15
4	x	25 RM	25,6	1480	0,727

Number and cross-sectional area of conductor			Approximate overall diameter	Approximate net weight of cables	Maximum conductor resistance at 20°C
n x mm ²			mm	kg/km	W/km
4	x	35 RM	28,1	1918	0,524
4	x	50 RM	33,3	2637	0,387
4	x	70 RM	36,8	3550	0,268
4	x	95 RM	43,1	4882	0,193
4	x	120 RM	46,6	5968	0,153
4	x	150 RM	51,8	7334	0,124
4	x	185 RM	57,0	9087	0,0991
4	x	240 RM	64,4	11716	0,0754
5	x	1,5 RE	14,0	282	12,1
5	x	2,5 RE	15,0	351	7,41
5	x	4 RE	16,3	449	4,61
5	x	6 RE	17,6	570	3,08
5	x	10 RE	19,9	818	1,83
5	x	10 RM	20,7	854	1,83
5	x	16 RM	23,5	1205	1,15
5	x	25 RM	28,1	1800	0,727
5	x	35 RM	31,3	2373	0,524
5	x	50 RM	36,9	3238	0,387
5	x	70 RM	40,7	4365	0,268
5	x	95 RM	47,6	5999	0,193
5	x	120 RM	51,8	7370	0,153
5	x	150 RM	57,8	9091	0,124
5	x	185 RM	63,3	11220	0,0991
5	x	240 RM	71,7	14507	0,0754
7	x	1,5 RE	15,1	335	12,1
7	x	2,5 RE	16,2	423	7,41
7	x	4 RM	18,5	586	4,61
10	x	1,5 RE	18,8	476	12,1
10	x	1,5 RM	19,6	504	12,1
10	x	2,5 RE	20,4	605	7,41
10	x	2,5 RM	21,4	645	7,41
12	x	1,5 RE	19,4	524	12,1
12	x	1,5 RM	20,2	554	12,1
12	x	2,5 RE	21,0	672	7,41
12	x	2,5 RM	22,0	714	7,41
14	x	1,5 RE	20,3	581	12,1
14	x	1,5 RM	21,2	615	12,1
14	x	2,5 RE	22,0	750	7,41
14	x	2,5 RM	23,1	797	7,41

Number and cross-sectional area of conductor			Approximate overall diameter	Approximate net weight of cables	Maximum conductor resistance at 20°C
n x mm ²			mm	kg/km	W/km
16	x	1,5 RM	22,3	686	12,1
16	x	2,5 RE	23,1	839	7,41
16	x	2,5 RM	24,3	892	7,41
19	x	1,5 RE	22,4	725	12,1
19	x	1,5 RM	23,4	767	12,1
19	x	2,5 RE	24,3	946	7,41
19	x	2,5 RM	25,6	1005	7,41
20	x	1,5 RE	23,5	775	12,1
20	x	1,5 RM	24,5	820	12,1
24	x	1,5 RE	26,0	904	12,1
24	x	1,5 RM	27,2	957	12,1
24	x	2,5 RE	28,4	1196	7,41
24	x	2,5 RM	29,9	1271	7,41
30	x	1,5 RE	27,4	1056	12,1
30	x	1,5 RM	28,7	1117	12,1
30	x	2,5 RE	30,3	1428	7,41
30	x	2,5 RM	31,9	1516	7,41
37	x	1,5 RE	29,9	1278	12,1
37	x	1,5 RM	31,3	1351	12,1
3	x	25RM/16RM	24,5	1375	0,727 / 1,15
3	x	35RM/16RM	26,4	1715	0,524 / 1,15
3	x	50RM/25RM	31,3	2380	0,387 / 0,727
3	x	70RM/35RM	34,6	3186	0,268 / 0,524
3	x	95RM/50RM	40,4	4357	0,193 / 0,387
3	x	120RM/70RM	44,1	5430	0,153 / 0,268
3	x	150RM/70RM	48,0	6501	0,124 / 0,268
3	x	185RM/95RM	53,3	8125	0,0991 / 0,193
3	x	240RM/120RM	59,9	10454	0,0754 / 0,153

Halogen-free low
smoke fire resistant
security power cables

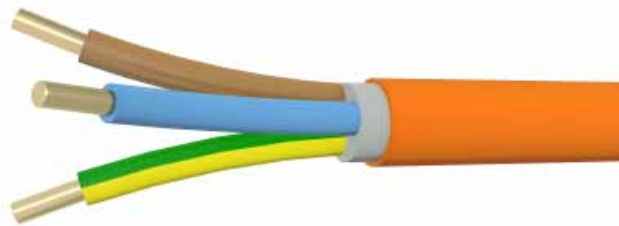

FIRE PERFORMANCE

Insulation integrity FE 180:	DIN VDE 0472-814 (800°C, 180 min.), IEC 60331-21
System integrity E90:	DIN 4102-12 (90 min.)
Flame propagation:	DIN EN 50266-2-2, VDE 0482-266-2-2, IEC 60332-3-22
Smoke density:	DIN EN 61034-2, VDE 0482-1034-2, IEC 61034-2
Gases evolved during combustion:	DIN EN 50267-2-2, VDE 0482-267-2-2, IEC 60754-2: pH ≥ 4,3; conductivity ≤ 2,5 μS/mm

CONSTRUCTION

Conductors:	bare copper conductor, circular solid class 1 (RE) or stranded circular or circular compacted class 2 (RM) according to EN 60228
Insulation:	special fire resistant cross-linked compound
Inner covering:	special flame-retardant and halogen-free compound
Sheath:	thermoplastic halogen-free compound type HM4 according to HD 604 S1
Colour of sheath:	orange

CHARACTERISTIC

Core identification: according to HD 308 S2 or EN 50334

	(N)HXH-O FE180/E90	(N)HXH-J FE180/E90
	without protective conductor	with protective conductor
1-core:	black	green-yellow
2-core:	blue, brown	—
3-core:	brown, black, grey	green-yellow, blue, brown
4-core:	blue, brown, black, grey	green-yellow, brown, black, grey
5-core:	blue, brown, black, grey, black	green-yellow, blue, brown, black, grey
more 5-core:	black with numbering	green-yellow, others cores black with numbering

Maximum conductor operating temperature: +90°C

Lowest ambient temperature for fixed installation: -30°C

Lowest installation temperature: -5°C

Maximum short-circuit conductor temperature: +250°C

Minimum bending radius: 15D - for single core cable; 12D - for multicore cable (D - overall cable diameter)

Maximum permissible tensile stress with cable grip for Cu-conductor: 50 N/mm²

Application: Fire resistant security cables for installation everywhere where high safety requirements have a special significance e.g., in industrial complexes, power stations, public buildings, hotels, underground railway systems, hospitals etc.

Standard packing: 500 m on drums. Other forms of packing and delivery are available on request.

Number and cross-sectional area of conductor			Approximate overall diameter	Approximate net weight of cables	Maximum conductor resistance at 20°C
n x mm ²			mm	kg/km	W/km
1	x	1,5RE	7,4	71	12,1
1	x	2,5RE	7,7	84	7,41
1	x	4RE	8,2	103	4,61
1	x	6RE	8,7	125	3,08
1	x	10RE	9,5	170	1,83
1	x	16RM	10,8	240	1,15
1	x	25RM	12,5	347	0,727
1	x	35RM	13,6	446	0,524
1	x	50RM	15,5	590	0,387
1	x	70RM	17,0	801	0,268
1	x	95RM	19,8	1094	0,193
1	x	120RM	21,2	1333	0,153
1	x	150RM	23,6	1643	0,124
1	x	185RM	25,7	2023	0,0991
1	x	240RM	29,0	2609	0,0754
1	x	300RM	31,6	3237	0,0601
1	x	400RM	36,2	4183	0,0470
2	x	1,5RE	14,1	268	12,1
2	x	2,5RE	14,9	310	7,41
2	x	4RE	15,8	367	4,61
2	x	6RE	16,8	435	3,08
2	x	10RE	18,4	562	1,83
2	x	16RM	21,0	776	1,15
2	x	25RM	24,4	1098	0,727
3	x	1,5RE	14,8	296	12,1
3	x	2,5RE	15,6	347	7,41
3	x	4RE	16,6	417	4,61
3	x	6RE	17,7	503	3,08
3	x	10RE	19,4	665	1,83
3	x	16RM	22,2	932	1,15
3	x	25RM	25,9	1337	0,727
3	x	35RM	28,2	1694	0,524
3	x	50RM	32,8	2296	0,387
3	x	70RM	36,0	3025	0,268
3	x	95RM	41,6	4106	0,193
3	x	120RM	45,1	5002	0,153
3	x	150RM	50,3	6177	0,124
3	x	185RM	55,4	7643	0,0991
3	x	240RM	62,5	9825	0,0754
4	x	1,5RE	16,0	345	12,1
4	x	2,5RE	16,9	407	7,41
4	x	4RE	18,0	495	4,61
4	x	6RE	19,2	603	3,08
4	x	10RE	21,1	809	1,83
4	x	16RM	24,3	1144	1,15

Number and cross-sectional area of conductor			Approximate overall diameter	Approximate net weight of cables	Maximum conductor resistance at 20°C
n x mm ²			mm	kg/km	W/km
4	x	25RM	28,4	1655	0,727
4	x	35RM	31,2	2126	0,524
4	x	50RM	36,3	2879	0,387
4	x	70RM	39,8	3815	0,268
4	x	95RM	46,6	5240	0,193
4	x	120RM	50,1	6355	0,153
4	x	150RM	56,2	7879	0,124
4	x	185RM	61,4	9683	0,0991
4	x	240RM	69,5	12491	0,0754
5	x	1,5RE	17,3	402	12,1
5	x	2,5RE	18,3	478	7,41
5	x	4RE	19,6	586	4,61
5	x	6RE	20,9	717	3,08
5	x	10RE	23,0	969	1,83
5	x	16RM	26,6	1380	1,15
5	x	25RM	31,4	2022	0,727
5	x	35RM	34,6	2619	0,524
5	x	50RM	40,2	3525	0,387
5	x	70RM	44,2	4705	0,268
5	x	95RM	51,5	6428	0,193
5	x	120RM	55,9	7867	0,153
5	x	150RM	62,3	9701	0,124
5	x	185RM	68,4	11968	0,0991
5	x	240RM	77,4	15444	0,0754
7	x	1,5RE	18,7	472	12,1
7	x	2,5RE	19,8	569	7,41
7	x	4RM	22,1	751	4,61
8	x	1,5RE	20,0	523	12,1
10	x	1,5RE	23,2	659	12,1
10	x	1,5RM	24,0	694	12,1
10	x	2,5RE	24,8	801	7,41
12	x	1,5RE	23,9	721	12,1
12	x	2,5RE	25,5	882	7,41
14	x	1,5RE	25,1	798	12,1
14	x	2,5RE	26,8	982	7,41
19	x	1,5RE	27,8	992	12,1
19	x	2,5RE	30,1	1263	7,41
20	x	1,5RE	29,4	1079	12,1
20	x	1,5RM	30,4	1135	12,1

Number and cross-sectional area of conductor			Approximate overall diameter	Approximate net weight of cables	Maximum conductor resistance at 20°C
n x mm ²			mm	kg/km	W/km
24	x	2,5RE	35,4	1612	7,41
30	x	1,5RE	35,0	1510	12,1
30	x	2,5RE	37,5	1885	7,41
3	x	25RM+16RM	27,6	1561	0,727 / 1,15
3	x	35RM+16RM	29,5	1917	0,524 / 1,15
3	x	50RM+25RM	34,5	2631	0,387 / 0,727
3	x	70RM+35RM	37,8	3461	0,268 / 0,524
3	x	95RM+50RM	44,1	4742	0,193 / 0,387
3	x	120RM+70RM	47,7	5822	0,153 / 0,268
3	x	150RM+70RM	51,9	6979	0,124 / 0,268
3	x	185RM+95RM	57,9	8744	0,0991 / 0,193
3	x	240RM+120RM	64,7	11176	0,0754 / 0,153
4	x	35RM+16RM	33,3	2429	0,524 / 1,15
4	x	50RM+25RM	38,6	3279	0,387 / 0,727
4	x	70RM+35RM	42,4	4349	0,268 / 0,524
4	x	95RM+50RM	49,6	5959	0,193 / 0,387
4	x	120RM+70RM	53,5	7305	0,153 / 0,268
4	x	150RM+70RM	59,0	8864	0,124 / 0,268

Halogen-free low
smoke fire resistant
security power cables

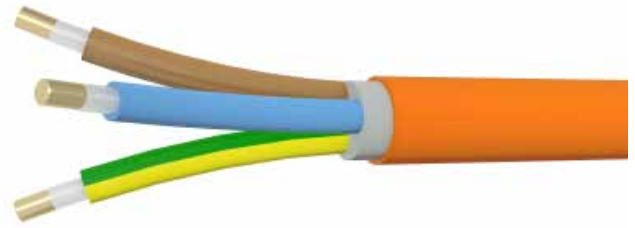
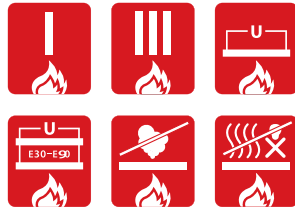

FIRE PERFORMANCE

Insulation integrity FE 180:	DIN VDE 0472-814 (800°C, 180 min.), IEC 60331-21
System integrity E30:	DIN 4102-12 (90 min.)
Flame propagation:	DIN EN 50266-2-2, VDE 0482-266-2-2, IEC 60332-3-22
Smoke density:	DIN EN 61034-2, VDE 0482-1034-2, IEC 61034-2
Gases evolved during combustion:	DIN EN 50267-2-2, VDE 0482-267-2-2, IEC 60754-2: pH ≥ 4,3; conductivity ≤ 2,5 μS/mm

CONSTRUCTION

Conductors:	bare copper conductor, circular solid class 1 (RE) or stranded circular or circular compacted class 2 (RM) according to EN 60228
Primary insulation:	a suitable wrapping of mica tape with a glass cloth
Insulation:	special fire resistant cross-linked compound
Inner covering:	special flame-retardant and halogen-free compound
Sheath:	thermoplastic halogen-free compound type HM4 according to HD 604 S1

CHARACTERISTIC

Colour of sheath:	orange
Core identification:	according to HD 308 S2

	NHXH-O FE180/E30	NHXH-J FE180/E30
	without protective conductor	with protective conductor
1-core:	black	green-yellow
2-core:	blue, brown	—
3-core:	brown, black, grey	green-yellow, blue, brown
4-core:	blue, brown, black, grey	green-yellow, brown, black, grey
5-core:	blue, brown, black, grey, black	green-yellow, blue, brown, black, grey
more 5-core:	black with numbering	green-yellow, others cores black with numbering

Maximum conductor operating temperature:	+90°C
Lowest ambient temperature for fixed installation:	-30°C
Lowest installation temperature:	-5°C
Maximum short-circuit conductor temperature:	+250°C
Minimum bending radius:	15D - for single core cable; 12D - for multicore cable (D - overall cable diameter)
Maximum permissible tensile stress with cable grip for Cu-conductor:	50 N/mm ²
Application:	Fire resistant security cables for installation everywhere where high safety requirements have a special significance e.g., in industrial complexes, power stations, public buildings, hotels, underground railway systems, hospitals etc.
Standard packing:	500 m on drums. Other forms of packing and delivery are available on request.

Number and cross-sectional area of conductor			Approximate overall diameter	Approximate net weight of cables	Maximum conductor resistance at 20°C
n x mm ²			mm	kg/km	W/km
1	x	1,5RE	8,2	86	12,1
1	x	2,5RE	8,6	101	7,41
1	x	4RE	9,0	120	4,61
1	x	6RE	9,5	144	3,08
1	x	10RE	10,3	191	1,83
1	x	16RM	11,6	263	1,15
1	x	25RM	13,4	376	0,727
1	x	35RM	14,5	478	0,524
1	x	50RM	16,4	628	0,387
1	x	70RM	17,9	842	0,268
1	x	95RM	20,7	1143	0,193
1	x	120RM	22,1	1387	0,153
1	x	150RM	24,6	1703	0,124
1	x	185RM	26,7	2089	0,0991
1	x	240RM	30,0	2685	0,0754
1	x	300RM	32,6	3318	0,0601
1	x	400RM	37,2	4279	0,0470
2	x	1,5RE	15,8	334	12,1
2	x	2,5RE	16,6	380	7,41
2	x	4RE	17,5	441	4,61
2	x	6RE	18,5	514	3,08
2	x	10RE	20,0	649	1,83
2	x	16RM	22,7	874	1,15
2	x	25RM	26,3	1226	0,727
3	x	1,5RE	16,6	369	12,1
3	x	2,5RE	17,5	425	7,41
3	x	4RE	18,4	500	4,61
3	x	6RE	19,5	592	3,08
3	x	10RE	21,2	765	1,83
3	x	16RM	24,0	1042	1,15
3	x	25RM	27,9	1479	0,727
3	x	35RM	30,2	1847	0,524
3	x	50RM	34,9	2480	0,387
3	x	70RM	38,0	3223	0,268
3	x	95RM	43,8	4346	0,193
3	x	120RM	47,2	5263	0,153
3	x	150RM	52,4	6467	0,124
3	x	185RM	57,6	7963	0,0991
3	x	240RM	64,6	10187	0,0754
4	x	1,5RE	18,0	432	12,1
4	x	2,5RE	19,0	502	7,41
4	x	4RE	20,1	597	4,61
4	x	6RE	21,2	711	3,08
4	x	10RE	23,2	929	1,83
4	x	16RM	26,3	1278	1,15
4	x	25RM	30,7	1828	0,727

Number and cross-sectional area of conductor			Approximate overall diameter	Approximate net weight of cables	Maximum conductor resistance at 20°C
n x mm ²			mm	kg/km	W/km
4	x	35RM	33,4	2311	0,524
4	x	50RM	38,6	3103	0,387
4	x	70RM	42,1	4058	0,268
4	x	95RM	48,9	5531	0,193
4	x	120RM	52,5	6675	0,153
4	x	150RM	58,6	8236	0,124
4	x	185RM	63,8	10071	0,0991
4	x	240RM	71,9	12936	0,0754
5	x	1,5RE	19,6	507	12,1
5	x	2,5RE	20,6	590	7,41
5	x	4RE	21,8	706	4,61
5	x	6RE	23,2	847	3,08
5	x	10RE	25,3	1115	1,83
5	x	16RM	28,9	1543	1,15
5	x	25RM	33,9	2232	0,727
5	x	35RM	37,2	2850	0,524
5	x	50RM	42,7	3795	0,387
5	x	70RM	46,8	5004	0,268
5	x	95RM	54,2	6786	0,193
5	x	120RM	58,5	8259	0,153
5	x	150RM	65,0	10139	0,124
5	x	185RM	71,1	12444	0,0991
5	x	240RM	80,1	15990	0,0754
7	x	1,5RE	21,2	598	12,1
7	x	2,5RE	22,3	704	7,41
7	x	4RM	24,7	897	4,61
8	x	1,5RE	22,8	664	12,1
10	x	1,5RE	26,6	843	12,1
10	x	1,5RM	27,4	880	12,1
10	x	2,5RE	28,1	996	7,41
12	x	1,5RE	27,4	924	12,1
12	x	2,5RE	29,0	1100	7,41
14	x	1,5RE	28,8	1024	12,1
14	x	2,5RE	30,5	1225	7,41
19	x	1,5RE	32,0	1280	12,1
19	x	2,5RE	34,3	1578	7,41
20	x	1,5RE	33,8	1391	12,1
20	x	1,5RM	34,9	1453	12,1
24	x	1,5RE	38,0	1662	12,1
24	x	2,5RE	40,5	2018	7,41
30	x	1,5RE	40,4	1952	12,1
30	x	2,5RE	42,9	2362	7,41

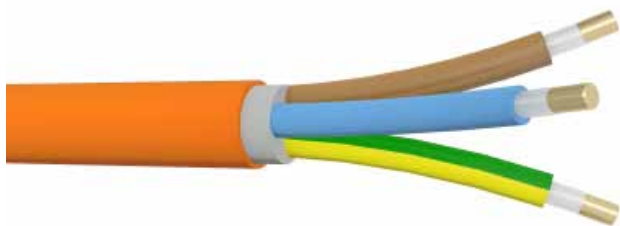

**Halogen-free low
smoke fire resistant
security power cables**

FIRE PERFORMANCE

Insulation integrity FE 180:	DIN VDE 0472-814 (800°C, 180 min.), IEC 60331-21
System integrity E30:	DIN 4102-12 (30 min.)
Flame propagation:	DIN EN 50266-2-2, VDE 0482-266-2-2, IEC 60332-3-22
Smoke density:	DIN EN 61034-2, VDE 0482-1034-2, IEC 61034-2
Gases evolved during combustion:	DIN EN 50267-2-2, VDE 0482-267-2-2, IEC 60754-2: pH ≥ 4,3; conductivity ≤ 2,5 μS/mm

CONSTRUCTION

Conductors:	bare copper conductor, circular solid class 1 (RE) or stranded circular or circular compacted class 2 (RM) according to EN 60228
Primary insulation:	a suitable wrapping of mica tape with a glass cloth
Insulation:	special fire resistant cross-linked compound
Inner covering:	special flame-retardant and halogen-free compound
Sheath:	thermoplastic halogen-free compound type HM4 according to HD 604 S1
Colour of sheath:	orange

CHARACTERISTIC

Core identification:	according to HD 308 S2	
	NHXX-O FE180/E90	NHXX-J FE180/E90
	without protective conductor	with protective conductor
1-core:	black	green-yellow
2-core:	blue, brown	—
3-core:	brown, black, grey	green-yellow, blue, brown
4-core:	blue, brown, black, grey	green-yellow, brown, black, grey
5-core:	blue, brown, black, grey, black	green-yellow, blue, brown, black, grey
more 5-core:	black with numbering	green-yellow, others cores black with numbering
Maximum conductor operating temperature:	+90°C	
Lowest ambient temperature for fixed installation:	-30°C	
Lowest installation temperature:	-5°C	
Maximum short-circuit conductor temperature:	+250°C	
Minimum bending radius:	15D – for single core cable; 12D – for multicore cable (D – overall cable diameter)	
Maximum permissible tensile stress with cable grip for Cu-conductor:	50 N/mm ²	
Application:	Fire resistant security cables for installation everywhere where high safety requirements have a special significance e.g., in industrial complexes, power stations, public buildings, hotels, underground railway systems, hospitals etc.	
Standard packing:	500 m on drums. Other forms of packing and delivery are available on request.	

Number and cross-sectional area of conductor			Approximate overall diameter	Approximate net weight of cables	Maximum conductor resistance at 20°C
n x mm ²			mm	kg/km	W/km
1	x	1,5RE	8,2	86	12,1
1	x	2,5RE	8,6	101	7,41
1	x	4RE	9,0	120	4,61
1	x	6RE	9,5	144	3,08
1	x	10RE	10,3	191	1,83
1	x	16RM	11,6	263	1,15
1	x	25RM	13,4	376	0,727
1	x	35RM	14,5	478	0,524
1	x	50RM	16,4	628	0,387
1	x	70RM	17,9	842	0,268
1	x	95RM	20,7	1143	0,193
1	x	120RM	22,1	1387	0,153
1	x	150RM	24,6	1703	0,124
1	x	185RM	26,7	2089	0,0991
1	x	240RM	30,0	2685	0,0754
1	x	300RM	32,6	3318	0,0601
1	x	400RM	37,2	4279	0,0470
2	x	1,5RE	15,8	334	12,1
2	x	2,5RE	16,6	380	7,41
2	x	4RE	17,5	441	4,61
2	x	6RE	18,5	514	3,08
2	x	10RE	20,0	649	1,83
2	x	16RM	22,7	874	1,15
2	x	25RM	26,3	1226	0,727
3	x	1,5RE	16,6	369	12,1
3	x	2,5RE	17,5	425	7,41
3	x	4RE	18,4	500	4,61
3	x	6RE	19,5	592	3,08
3	x	10RE	21,2	765	1,83
3	x	16RM	24,0	1042	1,15
3	x	25RM	27,9	1479	0,727
3	x	35RM	30,2	1847	0,524
3	x	50RM	34,9	2480	0,387
3	x	70RM	38,0	3223	0,268
3	x	95RM	43,8	4346	0,193
3	x	120RM	47,2	5263	0,153
3	x	150RM	52,4	6467	0,124
3	x	185RM	57,6	7963	0,0991
3	x	240RM	64,6	10187	0,0754
4	x	1,5RE	18,0	432	12,1
4	x	2,5RE	19,0	502	7,41
4	x	4RE	20,1	597	4,61
4	x	6RE	21,2	711	3,08
4	x	10RE	23,2	929	1,83
4	x	16RM	26,3	1278	1,15
4	x	25RM	30,7	1828	0,727
4	x	35RM	33,4	2311	0,524
4	x	50RM	38,6	3103	0,387
4	x	70RM	42,1	4058	0,268
4	x	95RM	48,9	5531	0,193
4	x	120RM	52,5	6675	0,153
4	x	150RM	58,6	8236	0,124

Number and cross-sectional area of conductor			Approximate overall diameter	Approximate net weight of cables	Maximum conductor resistance at 20°C
n x mm ²			mm	kg/km	W/km
4	x	185RM	63,8	10071	0,0991
4	x	240RM	71,9	12936	0,0754
5	x	1,5RE	19,6	507	12,1
5	x	2,5RE	20,6	590	7,41
5	x	4RE	21,8	706	4,61
5	x	6RE	23,2	847	3,08
5	x	10RE	25,3	1115	1,83
5	x	16RM	28,9	1543	1,15
5	x	25RM	33,9	2232	0,727
5	x	35RM	37,2	2850	0,524
5	x	50RM	42,7	3795	0,387
5	x	70RM	46,8	5004	0,268
5	x	95RM	54,2	6786	0,193
5	x	120RM	58,5	8259	0,153
5	x	150RM	65,0	10139	0,124
5	x	185RM	71,1	12444	0,0991
5	x	240RM	80,1	15990	0,0754
7	x	1,5RE	21,2	598	12,1
7	x	2,5RE	22,3	704	7,41
7	x	4RM	24,7	897	4,61
8	x	1,5RE	22,8	664	12,1
10	x	1,5RE	26,6	843	12,1
10	x	1,5RM	27,4	880	12,1
10	x	2,5RE	28,1	996	7,41
12	x	1,5RE	27,4	924	12,1
12	x	2,5RE	29,0	1100	7,41
14	x	1,5RE	28,8	1024	12,1
14	x	2,5RE	30,5	1225	7,41
19	x	1,5RE	32,0	1280	12,1
19	x	2,5RE	34,3	1578	7,41
20	x	1,5RE	33,8	1391	12,1
20	x	1,5RM	34,9	1453	12,1
24	x	1,5RE	38,0	1662	12,1
24	x	2,5RE	40,5	2018	7,41
30	x	1,5RE	40,4	1952	12,1
30	x	2,5RE	42,9	2362	7,41

Halogen-free low smoke fire resistant security power cables with copper concentric conductor



FIRE PERFORMANCE

Insulation integrity FE 180:	DIN VDE 0472-814 (800°C, 180 min.), IEC 60331-21
System integrity E30:	DIN 4102-12 (30 min.)
Flame propagation:	DIN EN 50266-2-2, VDE 0482-266-2-2, IEC 60332-3-22
Smoke density:	DIN EN 61034-2, VDE 0482-1034-2, IEC 61034-2
Gases evolved during combustion:	DIN EN 50267-2-2, VDE 0482-267-2-2, IEC 60754-2: pH ≥ 4,3; conductivity ≤ 2,5 μS/mm

CONSTRUCTION

Conductors:	bare copper conductor, circular solid class 1 (RE) or stranded circular or circular compacted class 2 (RM) according to EN 60228
Insulation:	special fire resistant cross-linked compound
Inner covering:	special flame-retardant and halogen-free compound
Concentric conductor:	inner layer - round copper wires, outer layer - copper tape
Separator:	tape
Sheath:	thermoplastic halogen-free compound type HM4 according to DIN VDE 0276-604

CHARACTERISTIC

Colour of sheath:	orange
Core identification:	according to HD 308 S2 or EN 50334
2-core:	blue, brown
3-core:	brown, black, grey
3 core:*	blue, brown, black
4-core:	blue, brown, black, grey
≥ 7-core:	black with numbering
*For certain applications only.	
Maximum conductor operating temperature:	+90°C
Lowest ambient temperature for fixed installation:	-30°C
Lowest installation temperature:	-5°C
Maximum short-circuit conductor temperature:	+250°C
Minimum bending radius:	15D - for single core cable; 12D - for multicore cable (D - overall cable diameter)
Maximum permissible tensile stress with cable grip for Cu-conductor:	50 N/mm ² , (total cross-section of the conductors, any screen not included)
Application:	Fire resistant security cables for installation everywhere where high safety requirements have a special significance e.g., in industrial complexes, power stations, public buildings, hotels, underground railway systems, hospitals etc.
Standard packing:	500 m or 1000m on drums. Other forms of packing and delivery are available on request.

Number and cross-sectional area of conductor		Approximate overall diameter	Approximate net weight of cables	Maximum conductor resistance at 20°C
n x mm ²		mm	kg/km	W/km
2	x 1,5 RE/1,5	13,9	256	12,1 / 12,1
2	x 2,5 RE/2,5	14,6	302	7,41 / 7,41
2	x 4 RE/4	15,9	377	4,61 / 4,61
2	x 6 RE/6	17,2	460	3,08 / 3,08
2	x 10 RE/10	18,9	620	1,83 / 1,83
2	x 16 RM/16	22,0	886	1,15 / 1,15
3	x 1,5 RE/1,5	14,4	280	12,1 / 12,1
3	x 2,5 RE/2,5	15,2	335	7,41 / 7,41
3	x 4 RE/4	16,6	423	4,61 / 4,61
3	x 6 RE/6	18,0	524	3,08 / 3,08
3	x 10 RE/10	19,8	718	1,83 / 1,83
3	x 16 RM/16	23,1	1038	1,15 / 1,15
3	x 25 RM/16	26,8	1434	0,727 / 1,15
3	x 35 RM/16	29,1	1784	0,524 / 1,15
3	x 50 RM/25	33,2	2423	0,387 / 0,727
3	x 70 RM/35	37,3	3284	0,268 / 0,524
3	x 95 RM/50	42,7	4445	0,193 / 0,387
3	x 120 RM/70	46,4	5503	0,135 / 0,268
3	x 150 RM/70	51,6	6673	0,124 / 0,268
3	x 185 RM/95	55,9	8249	0,0991 / 0,193
3	x 240 RM/120	62,9	10639	0,0754 / 0,153
4	x 1,5 RE/1,5	15,3	318	12,1 / 12,1
4	x 2,5 RE/2,5	16,3	385	7,41 / 7,41
4	x 4 RE/4	17,8	490	4,61 / 4,61
4	x 6 RE/6	19,2	612	3,08 / 3,08
4	x 10 RE/10	21,3	849	1,83 / 1,83
4	x 16 RM/16	24,9	1234	1,15 / 1,15
4	x 25 RM/16	29,1	1733	0,727 / 1,15
4	x 35 RM/16	31,8	2196	0,524 / 1,15
4	x 50 RM/25	36,8	3020	0,387 / 0,727
4	x 70 RM/35	41,0	4072	0,268 / 0,524
4	x 95 RM/50	47,3	5548	0,193 / 0,387
4	x 120 RM/70	51,5	6875	0,153 / 0,268
4	x 150 RM/70	56,7	8269	0,124 / 0,268
4	x 185 RM/95	62,0	10320	0,0991 / 0,193
4	x 240 RM/120	69,5	13227	0,0754 / 0,153
5	x 1,5 RE/1,5	16,3	370	12,1 / 12,1
5	x 2,5 RE/2,5	17,3	444	7,41 / 7,41
5	x 4 RE/4	19,0	568	4,61 / 4,61
5	x 6 RE/6	20,6	714	3,08 / 3,08
5	x 10 RE/10	22,8	997	1,83 / 1,83
5	x 16 RM/16	25,8	1394	1,15 / 1,15
5	x 25 RM/16	31,5	2017	0,727 / 1,15
5	x 35 RM/16	33,9	2570	0,524 / 1,15
5	x 50 RM/25	40,4	3557	0,387 / 0,727
5	x 70 RM/35	44,7	4790	0,268 / 0,524
5	x 95 RM/50	51,8	6554	0,193 / 0,387
5	x 120 RM/70	56,4	8121	0,135 / 0,268
5	x 150 RM/70	62,8	9894	0,124 / 0,268
5	x 185 RM/95	68,1	12221	0,0991 / 0,193
7	1,5 RE/2,5	17,4	426	12,1 / 7,41
7	2,5 RE/2,5	18,6	519	7,41 / 7,41

Number and cross-sectional area of conductor			Approximate overall diameter	Approximate net weight of cables	Maximum conductor resistance at 20°C
n x mm ²			mm	kg/km	W/km
8	x	2,5 RE/4	20,1	592	7,41 / 4,61
10	x	1,5 RE/2,5	21,0	571	12,1 / 7,41
10	x	2,5 RE/4	22,8	723	7,41 / 4,61
12	x	1,5 RE/2,5	21,5	620	12,1 / 7,41
12	x	2,5 RE/4	23,4	792	7,41 / 4,61
14	x	1,5 RE/2,5	22,5	680	12,1 / 7,41
16	x	1,5 RE/4	23,7	769	12,1 / 4,61
19	x	1,5 RE/4	24,8	849	12,1 / 4,61
19	x	2,5 RE/6	36,6	1741	7,41 / 3,08
21	x	1,5 RE/6	26,0	930	12,1 / 3,08
21	x	2,5 RE/10	28,4	1218	7,41 / 1,83
24	x	1,5 RE/6	28,5	1056	12,1 / 3,08
24	x	2,5 RE/10	31,4	1397	7,41 / 1,83
30	x	1,5 RE/6	30,2	1228	12,1 / 3,08
30	x	2,5 RE/10	33,2	1665	7,41 / 1,83



Halogen-free low smoke fire resistant security power cables with copper concentric conductor

FIRE PERFORMANCE

Insulation integrity FE 180:	DIN VDE 0472-814 (800°C, 180 min.), IEC 60331-21
System integrity E30:	DIN 4102-12 (90 min.)
Flame propagation:	DIN EN 50266-2-2, VDE 0482-266-2-2, IEC 60332-3-22
Smoke density:	DIN EN 61034-2, VDE 0482-1034-2, IEC 61034-2
Gases evolved during combustion:	DIN EN 50267-2-2, VDE 0482-267-2-2, IEC 60754-2: pH ≥ 4,3; conductivity ≤ 2,5 μS/mm

CONSTRUCTION

Conductors:	bare copper conductor, circular solid class 1 (RE) or stranded circular or circular compacted class 2 (RM) according to EN 60228
Insulation:	special fire resistant cross-linked compound
Inner covering:	special flame-retardant and halogen-free compound
Concentric conductor:	inner layer - round copper wires, outer layer - copper tape
Separator:	tape
Sheath:	thermoplastic halogen-free compound type HM4 according to DIN VDE 0276-604

CHARACTERISTIC

Colour of sheath:	orange
Core identification:	according to HD 308 S2 or EN 50334
2-core:	blue, brown
3-core:	brown, black, grey
3 core:*	blue, brown, black
4-core:	blue, brown, black, grey
5-core:	blue, brown, black, grey, black
≥ 7-core:	black with numbering
*For certain applications only.	
Maximum conductor operating temperature:	+90°C
Lowest ambient temperature for fixed installation:	-30°C
Lowest installation temperature:	-5°C
Maximum short-circuit conductor temperature:	+250°C
Minimum bending radius:	15D - for single core cable; 12D - for multicore cable (D - overall cable diameter)
Maximum permissible tensile stress with cable grip for Cu-conductor:	50 N/mm ² , (total cross-section in mm ² of the conductors (any screen not included))
Application:	Fire resistant security cables for installation everywhere where high safety requirements have a special significance e.g., in industrial complexes, power stations, public buildings, hotels, underground railway systems, hospitals etc.
Standard packing:	500 m on drums. Other forms of packing and delivery are available on request.

Number and cross-sectional area of conductor			Approximate overall diameter	Approximate net weight of cables	Maximum conductor resistance at 20°C
n x mm ²			mm	kg/km	W/km
2	x	1,5 RE/1,5	15,9	324	12,1 / 12,1
2	x	2,5 RE//2,5	16,6	374	7,41 / 7,41
2	x	4 RE/4	17,9	453	4,61 / 4,61
2	x	6 RE/6	19,2	541	3,08 / 3,08
2	x	10 RE/10	20,9	708	1,83 / 1,83
2	x	16 RM/16	24,0	988	1,15 / 1,15
2	x	25 RM/16	27,5	1319	0,727 / 1,15
2	x	35 RM/16	29,6	1598	0,524 / 1,15
3	x	1,5 RE/1,5	16,6	354	12,1 / 12,1
3	x	2,5 RE/2,5	17,4	413	7,41 / 7,41
3	x	4 RE/4	18,8	505	4,61 / 4,61
3	x	6 RE/6	20,1	612	3,08 / 3,08
3	x	10 RE/10	21,9	814	1,83 / 1,83
3	x	16 RM/16	25,3	1147	1,15 / 1,15
3	x	25 RM/16	29,0	1561	0,727 / 1,15
3	x	35 RM/16	31,2	1923	0,524 / 1,15
3	x	50 RM/25	35,9	2638	0,387 / 0,727
3	x	70 RM/35	39,6	3481	0,268 / 0,524
3	x	95 RM/50	45,5	4713	0,193 / 0,387
3	x	120 RM/70	49,5	5845	0,153 / 0,268
3	x	150 RM/70	54,8	7045	0,124 / 0,268
3	x	185RM/95	59,9	8773	0,0991 / 0,193
4	x	1,5 RE/1,5	17,8	404	12,1 / 12,1
4	x	2,5 RE/2,5	18,7	476	7,41 / 7,41
4	x	4 RE/4	20,2	587	4,61 / 4,61
4	x	6 RE/6	21,6	715	3,08 / 3,08
4	x	10 RE/10	23,7	961	1,83 / 1,83
4	x	16 RM/16	27,3	1363	1,15 / 1,15
4	x	25 RM/16	31,5	1885	0,727 / 1,15
4	x	35 RM/16	33,6	2357	0,524 / 1,15
4	x	50 RM/25	39,4	3232	0,387 / 0,727
4	x	70 RM/35	43,5	4285	0,268 / 0,524
4	x	95 RM/50	50,4	5869	0,193 / 0,387
4	x	120 RM/70	54,6	7223	0,153 / 0,268
4	x	150 RM/70	60,8	8808	0,124 / 0,268
4	x	185 RM/95	66,1	10872	0,0991 / 0,193
4	x	240 RM/120	74,2	13955	0,0754 / 0,153
5	x	1,5 RE/2,5	19,1	471	12,1 / 7,41
5	x	2,5 RE/2,5	20,1	550	7,41 / 7,41
5	x	4 RE/4	21,7	680	4,61 / 4,61
5	x	6 RE/6	23,0	830	3,08 / 3,08
5	x	10 RE/10	25,6	1125	1,83 / 1,83
5	x	16 RM/16	29,6	1604	1,15 / 1,15
5	x	25 RM/16	33,9	2254	0,727 / 1,15
5	x	35 RM/16	37,3	2881	0,524 / 1,15

Number and cross-sectional area of conductor			Approximate overall diameter	Approximate net weight of cables	Maximum conductor resistance at 20°C
n x mm ²			mm	kg/km	W/km
5	x	50 RM/25	43,3	3890	0,387 / 0,727
5	x	70 RM/35	48,3	5240	0,268 / 0,524
5	x	95 RM/50	55,5	7104	0,193 / 0,387
7	x	1,5 RE/2,5	20,4	544	12,1 / 7,41
7	x	2,5 RE/2,5	21,6	643	7,41 / 7,41
7	x	4 RM/4	24,1	849	4,61 / 4,61
10	x	1,5 RE/2,5	25,0	740	12,1 / 7,41
10	x	2,5 RE/4	26,8	903	7,41 / 4,61
12	x	1,5 RE/2,5	25,7	803	12,1 / 7,41
12	x	2,5 RE/4	27,5	986	7,41 / 4,61
16	x	2,5 RE/6	30,6	1241	7,41 / 3,08
19	x	1,5 RE/4	30,0	1115	12,1 / 4,61
19	x	2,5 RE/6	32,4	1413	7,41 / 3,08
21	x	1,5 RE/6	31,5	1219	12,1 / 3,08
21	x	2,5 RE/10	34,1	1576	7,41 / 1,83
24	x	1,5 RE/6	35,3	1448	12,1 / 3,08
24	x	2,5 RE/10	37,8	1816	7,41 / 1,83

Halogen-free low smoke fire resistant security power cables with copper concentric conductor

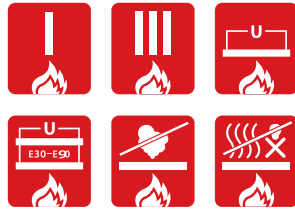

FIRE PERFORMANCE

Insulation integrity FE 180:	DIN VDE 0472-814 (800oC, 180 min.), IEC 60331-21
System integrity E30:	DIN VDE 4102-12 (30 min.)
Flame propagation:	DIN VDE 0482-266-2-2, DIN EN 50266-2-2, IEC 60332-3 -22
Smoke density:	DIN VDE 0472-1034-2 , IEC 61034-2
Gases evolved during combustion:	VDE 0482-267-2-2, DIN EN 50267-2-2 , IEC 60754-2: pH ≥ 4,3; conductivity ≤ 2,5 μS/mm

CONSTRUCTION

Conductors:	bare copper conductor, circular solid class 1 (RE) or stranded circular or circular compacted class 2 (RM) acc. to EN 60228
Primary insulation:	a suitable wrapping of mica tape with a glass cloth
Insulation:	special cross-linked compound
Inner covering:	special flame-retardant and halogen-free compound
Concentric conductor:	inner layer - round copper wires, outer layer - copper tape
Separator:	tape
Sheath:	thermoplastic halogen- free compound type HM4 acc. to DIN VDE 0276-604

CHARACTERISTIC

Colour of sheath:	orange
Core identification:	acc. to HD 308 S2
2-core:	blue, brown
3-core:	brown, black, grey
3 core-*	blue, brown, black
4-core:	blue, brown, black, grey
5-core:	blue, brown, black, grey, black
≥ 7-core:	black with numbering
Maximum conductor operating temperature:	+90°C
Lowest ambient temperature for fixed installation:	-30°C
Lowest installation temperature:	-5°C
Maximum short-circuit conductor temperature:	+250°C
Minimum bending radius:	15 x D - for single core cable; 12 x D - for multicore cable (D is the overall diameter of the cable)
Maximum permissible tensile stress with cable grip for Cu-conductor:	50 N/mm ² , calculated for the nominal sum of cross-sections of the inner conductors; the cross-section of the concentric conductors not be considered.
Application:	Fire resistant security cables for installation everywhere where high safety requirements have a special significance e.g., in industrial complexes, power stations, public buildings, hotels, underground railway systems, hospitals etc.
Standard packing:	500 m on drums. Other forms of packing and delivery are available on request.

*For certain applications only.

Number and cross-sectional area of conductor			Approximate overall diameter	Approximate net weight of cables	Maximum conductor resistance at 20°C
n x mm ²			mm	kg/km	W/km
2	x	1,5 RE/1,5	17,5	393	12,1 / 12,1
2	x	2,5 RE//2,5	18,3	447	7,41 / 7,41
2	x	4 RE/4	19,6	530	4,61 / 4,61
2	x	6 RE/6	20,9	624	3,08 / 3,08
2	x	10 RE/10	22,6	799	1,83 / 1,83
2	x	16 RM/16	25,7	1089	1,15 / 1,15
2	x	25 RM/16	29,4	1450	0,727 / 1,15
2	x	35 RM/16	31,5	1740	0,524 / 1,15
3	x	1,5 RE/1,5	18,4	430	12,1 / 12,1
3	x	2,5 RE/2,5	19,2	494	7,41 / 7,41
3	x	4 RE/4	20,6	592	4,61 / 4,61
3	x	6 RE/6	21,9	704	3,08 / 3,08
3	x	10 RE/10	23,7	916	1,83 / 1,83
3	x	16 RM/16	27,1	1260	1,15 / 1,15
3	x	25 RM/16	31,0	1708	0,727 / 1,15
3	x	35 RM/16	33,3	2082	0,524 / 1,15
3	x	50 RM/25	38,0	2827	0,387 / 0,727
3	x	70 RM/35	41,7	3686	0,268 / 0,524
3	x	95 RM/50	47,6	4958	0,193 / 0,387
3	x	120 RM/70	51,7	6114	0,153 / 0,268
3	x	150 RM/70	56,9	7344	0,124 / 0,268
3	x	185RM/95	62,0	9100	0,0991 / 0,193
4	x	1,5 RE/1,5	19,8	496	12,1 / 12,1
4	x	2,5 RE/2,5	20,7	573	7,41 / 7,41
4	x	4 RE/4	22,1	690	4,61 / 4,61
4	x	6 RE/6	23,4	824	3,08 / 3,08
4	x	10 RE/10	25,7	1084	1,83 / 1,83
4	x	16 RM/16	29,4	1501	1,15 / 1,15
4	x	25 RM/16	34,0	2079	0,727 / 1,15
4	x	35 RM/16	35,9	2549	0,524 / 1,15
4	x	50 RM/25	41,7	3463	0,387 / 0,727
4	x	70 RM/35	45,7	4535	0,268 / 0,524
4	x	95 RM/50	52,8	6170	0,193 / 0,387
4	x	120 RM/70	57,0	7552	0,153 / 0,268
4	x	150 RM/70	63,2	9175	0,124 / 0,268
4	x	185 RM/95	68,5	11270	0,0991 / 0,193
4	x	240 RM/120	76,6	14410	0,0754 / 0,153
5	x	1,5 RE/2,5	21,3	580	12,1 / 7,41
5	x	2,5 RE/2,5	22,4	665	7,41 / 7,41
5	x	4 RE/4	23,9	804	4,61 / 4,61
5	x	6 RE/6	25,3	963	3,08 / 3,08
5	x	10 RE/10	27,8	1274	1,83 / 1,83
5	x	16 RM/16	31,9	1771	1,15 / 1,15
5	x	25 RM/16	36,4	2472	0,727 / 1,15
5	x	35 RM/16	39,9	3119	0,524 / 1,15
5	x	50 RM/25	45,8	4169	0,387 / 0,727
5	x	70 RM/35	50,8	5548	0,268 / 0,524
5	x	95 RM/50	58,2	7471	0,193 / 0,387
7	x	1,5 RE/2,5	22,9	674	12,1 / 7,41
7	x	2,5 RE/2,5	24,1	783	7,41 / 7,41
7	x	4 RM/4	26,7	998	4,61 / 4,61

Number and cross-sectional area of conductor			Approximate overall diameter	Approximate net weight of cables	Maximum conductor resistance at 20°C
n x mm ²			mm	kg/km	W/km
10	x	1,5 RE/2,5	28,3	929	12,1 / 7,41
10	x	2,5 RE/4	30,1	1106	7,41 / 4,61
12	x	1,5 RE/2,5	29,2	1012	12,1 / 7,41
12	x	2,5 RE/4	31,0	1212	7,41 / 4,61
16	x	2,5 RE/6	34,5	1528	7,41 / 3,08
19	x	1,5 RE/4	34,2	1415	12,1 / 4,61
19	x	2,5 RE/6	36,6	1741	7,41 / 3,08
21	x	1,5 RE/6	36,0	1545	12,1 / 3,08
21	x	2,5 RE/10	38,6	1935	7,41 / 1,83
24	x	1,5 RE/6	40,3	1836	12,1 / 3,08
24	x	2,5 RE/10	42,8	2235	7,41 / 1,83

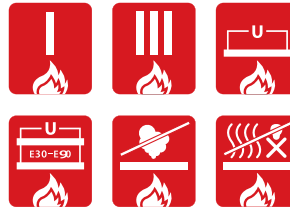

Halogen-free, low smoke, fire resistant security power cables with copper concentric conductor

FIRE PERFORMANCE

Insulation integrity FE 180:	DIN VDE 0472-814 (800oC, 180 min.), IEC 60331-21
System integrity E90:	DIN VDE 4102-12 (90 min.)
Flame propagation:	DIN VDE 0482-266-2-2, DIN EN 50266-2-2, IEC 60332-3 -22
Smoke density:	DIN VDE 0472-1034-2 , IEC 61034-2
Gases evolved during combustion:	VDE 0482-267-2-2, DIN EN 50267-2-2 , IEC 60754-2: pH ≥ 4,3; conductivity ≤ 2,5 μS/mm

CONSTRUCTION

Conductors:	bare copper conductor, circular solid class 1 (RE) or stranded circular or circular compacted class 2 (RM) acc. to EN 60228
Primary insulation:	A suitable wrapping of mica tape with a glass cloth
Insulation:	special cross-linked compound
Inner covering:	special flame-retardant and halogen-free compound
Concentric conductor:	inner layer - round copper wires, outer layer - copper tape
Separator:	tape
Sheath:	thermoplastic halogen- free compound type HM4 acc. to DIN VDE 0276-604

CHARACTERISTIC

Colour of sheath:	orange
Core identification:	acc. to HD 308 S2
2-core:	blue, brown
3-core:	brown, black, grey
3 core*:	blue, brown, black
4-core:	blue, brown, black, grey
5-core:	blue, brown, black, grey, black
≥ 7-core:	black with numbering
Maximum conductor operating temperature:	+90°C
Lowest ambient temperature for fixed installation:	-30°C
Lowest installation temperature:	-5°C
Maximum short-circuit conductor temperature:	+250°C
Minimum bending radius:	15 x D - for single core cable; 12 x D - for multicore cable (D is the overall diameter of the cable)
Maximum permissible tensile stress with cable grip for Cu-conductor:	50 N/mm ² , calculated for the nominal sum of cross-sections of the inner conductors; the cross-section of the concentric conductors not be considered.
Application:	Fire resistant security cables for installation everywhere where high safety requirements have a special significance e.g., in industrial complexes, power stations, public buildings, hotels, underground railway systems, hospitals etc.
Standard packing:	500 m on drums. Other forms of packing and delivery are available on request.

*For certain applications only.

Number and cross-sectional area of conductor			Approximate overall diameter	Approximate net weight of cables	Maximum conductor resistance at 20°C
n x mm ²			mm	kg/km	W/km
2	x	1,5 RE/1,5	17,5	393	12,1 / 12,1
2	x	2,5 RE//2,5	18,3	447	7,41 / 7,41
2	x	4 RE/4	19,6	530	4,61 / 4,61
2	x	6 RE/6	20,9	624	3,08 / 3,08
2	x	10 RE/10	22,6	799	1,83 / 1,83
2	x	16 RM/16	25,7	1089	1,15 / 1,15
2	x	25 RM/16	29,4	1450	0,727 / 1,15
2	x	35 RM/16	31,5	1740	0,524 / 1,15
3	x	1,5 RE/1,5	18,4	430	12,1 / 12,1
3	x	2,5 RE/2,5	19,2	494	7,41 / 7,41
3	x	4 RE/4	20,6	592	4,61 / 4,61
3	x	6 RE/6	21,9	704	3,08 / 3,08
3	x	10 RE/10	23,7	916	1,83 / 1,83
3	x	16 RM/16	27,1	1260	1,15 / 1,15
3	x	25 RM/16	31,0	1708	0,727 / 1,15
3	x	35 RM/16	33,3	2082	0,524 / 1,15
3	x	50 RM/25	38,0	2827	0,387 / 0,727
3	x	70 RM/35	41,7	3686	0,268 / 0,524
3	x	95 RM/50	47,6	4958	0,193 / 0,387
3	x	120 RM/70	51,7	6114	0,153 / 0,268
3	x	150 RM/70	56,9	7344	0,124 / 0,268
3	x	185RM/95	62,0	9100	0,0991 / 0,193
4	x	1,5 RE/1,5	19,8	496	12,1 / 12,1
4	x	2,5 RE/2,5	20,7	573	7,41 / 7,41
4	x	4 RE/4	22,1	690	4,61 / 4,61
4	x	6 RE/6	23,4	824	3,08 / 3,08
4	x	10 RE/10	25,7	1084	1,83 / 1,83
4	x	16 RM/16	29,4	1501	1,15 / 1,15
4	x	25 RM/16	34,0	2079	0,727 / 1,15
4	x	35 RM/16	35,9	2549	0,524 / 1,15
4	x	50 RM/25	41,7	3463	0,387 / 0,727
4	x	70 RM/35	45,7	4535	0,268 / 0,524
4	x	95 RM/50	52,8	6170	0,193 / 0,387
4	x	120 RM/70	57,0	7552	0,153 / 0,268
4	x	150 RM/70	63,2	9175	0,124 / 0,268
4	x	185 RM/95	68,5	11270	0,0991 / 0,193
4	x	240 RM/120	76,6	14410	0,0754 / 0,153
5	x	1,5 RE/2,5	21,3	580	12,1 / 7,41
5	x	2,5 RE/2,5	22,4	665	7,41 / 7,41
5	x	4 RE/4	23,9	804	4,61 / 4,61
5	x	6 RE/6	25,3	963	3,08 / 3,08
5	x	10 RE/10	27,8	1274	1,83 / 1,83
5	x	16 RM/16	31,9	1771	1,15 / 1,15
5	x	25 RM/16	36,4	2472	0,727 / 1,15
5	x	35 RM/16	39,9	3119	0,524 / 1,15

Number and cross-sectional area of conductor			Approximate overall diameter	Approximate net weight of cables	Maximum conductor resistance at 20°C
n x mm ²			mm	kg/km	W/km
5	x	50 RM/25	45,8	4169	0,387 / 0,727
5	x	70 RM/35	50,8	5548	0,268 / 0,524
5	x	95 RM/50	58,2	7471	0,193 / 0,387
7	x	1,5 RE/2,5	22,9	674	12,1 / 7,41
7	x	2,5 RE/2,5	24,1	783	7,41 / 7,41
7	x	4 RM/4	26,7	998	4,61 / 4,61
10	x	1,5 RE/2,5	28,3	929	12,1 / 7,41
10	x	2,5 RE/4	30,1	1106	7,41 / 4,61
12	x	1,5 RE/2,5	29,2	1012	12,1 / 7,41
12	x	2,5 RE/4	31,0	1212	7,41 / 4,61
16	x	2,5 RE/6	34,5	1528	7,41 / 3,08
19	x	1,5 RE/4	34,2	1415	12,1 / 4,61
19	x	2,5 RE/6	36,6	1741	7,41 / 3,08
21	x	1,5 RE/6	36,0	1545	12,1 / 3,08
21	x	2,5 RE/10	38,6	1935	7,41 / 1,83
24	x	1,5 RE/6	40,3	1836	12,1 / 3,08
24	x	2,5 RE/10	42,8	2235	7,41 / 1,83

Changing
the future
for energy
supply

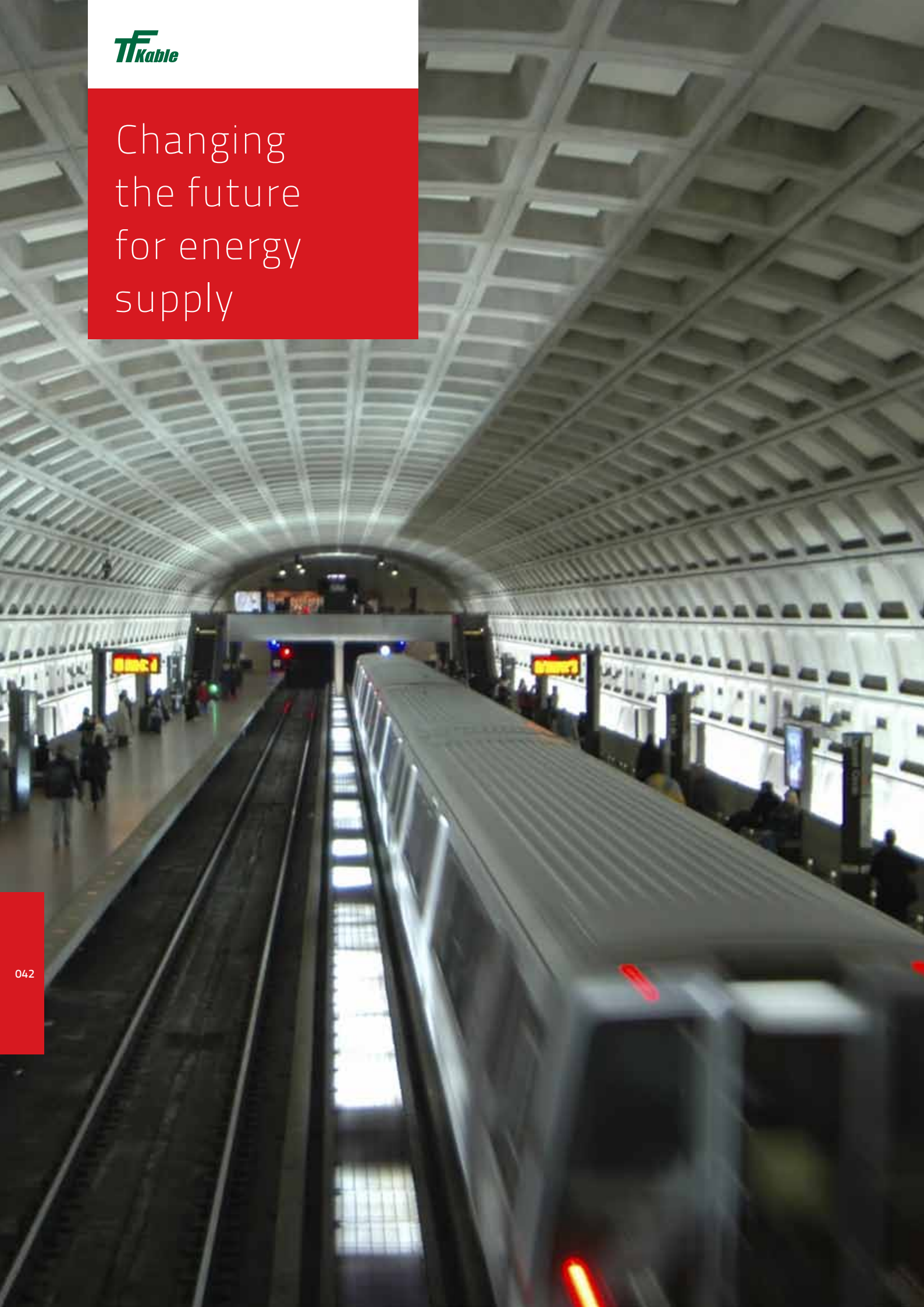

FLAME-X⁹⁵⁰ Standard 300/500V

BS 7629-1, BS 6387, BS 5839-1:200

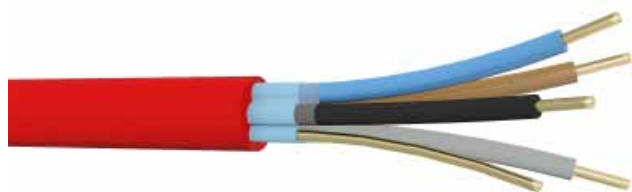

Standard level fire resistant electric cables having low emission of smoke and corrosive gases when affected by fire

FIRE PERFORMANCE

Fire resistance:	BS 6387 Category C, W, Z BS EN 50200 Class PH 30 BS 8434-1 duration 30 min. (15 min for the fire and impact and 15 min for the fire, impact and water) BS 5839-1:2002 Clause 26.2d PH 30 Standard fire resistant cable
Flame propagation:	BS EN 60332-1-2 and BS EN 50266-2-2
Smoke emission:	BS EN 61034-2
Gases evolved during combustion:	BS EN 50267-2-1: HCL ≤ 0,5%

CONSTRUCTION

Conductors:	plain annealed copper solid class 1 (for 1 - 2,5 mm ²) and stranded class 2 (for 4 mm ²) according to BS EN 60228
Uninsulated circuit protective conductor:	tinned annealed copper of the same nominal cross-sectional area and of the same class as the insulated conductors
Insulation:	special cross-linked heat resistant compound according to BS EN 50363.1
Optional binder:	non hygroscopic halogen free tape
Screen:	aluminium/polyester laminated tape and uninsulated circuit protective conductor
Outer sheath:	thermoplastic zero halogen low smoke compound according to BS 7655-6.1

CHARACTERISTIC

Colour of sheath:	red or white (other colours are permissible when agreed with the manufacturer)
Core identification:	2 core + ECC: brown, blue 3 core + ECC: brown, blue, grey 4 core + ECC: blue, brown, black, grey
Maximum conductor operating temperature:	+70°C
Lowest temperature ambient for fixed installation:	-30°C
Lowest installation temperature:	0°C
Maximum short-circuit conductor temperature:	+250°C
Minimum bending radius:	6D (D - is the overall cable diameter)
Application:	Standard level fire resistance cables in accordance with recommendations of BS 5839-1:2002 clause 26.2. Tested and approved by BASEC and LPCB. For use in Installations emergency lighting and evacuation systems, fire and smoke detection systems air-conditioning and alarm systems, automatic elevator doors, computer control rooms, emergency evacuation communicators.
Standard packing:	500 m on drums. Other forms of packing and delivery are available on request.

Cable Ref.	Conductor class	Nominal cross-section area of conductor	Nominal cross-sectional area of protective conductor	Approximate overall diameter	Approximate net weight of cable	Maximum conductor resistance at 20°C	Maximum ECC conductor resistance at 20°C
		mm ²	mm ²	mm	kg/km	W/km	W/km
FLAME-X 2x1 + ECC	1	1	1	7,1	65	18,1	18,2
FLAME-X 2x1.5 + ECC	1	1,5	1,5	8,0	86	12,1	12,2
FLAME-X 2x2.5 + ECC	1	2,5	2,5	9,3	126	7,41	7,56
FLAME-X 2x4 + ECC	2	4	4	11,1	186	4,61	4,70
FLAME-X 3x1 + ECC	1	1	1	7,5	81	18,1	18,2
FLAME-X 3x1.5 + ECC	1	1,5	1,5	8,4	108	12,1	12,2
FLAME-X 3x2.5 + ECC	1	2,5	2,5	9,9	159	7,41	7,56
FLAME-X 3x4 + ECC	2	4	4	11,7	237	4,61	4,70
FLAME-X 4x1 + ECC	1	1	1	8,3	100	18,1	18,2
FLAME-X 4x1.5 + ECC	1	1,5	1,5	9,6	135	12,1	12,2
FLAME-X 4x2.5 + ECC	1	2,5	2,5	11,4	199	7,41	7,56
FLAME-X 4x4 + ECC	2	4	4	14,6	303	4,61	4,70
*With protective conductor							

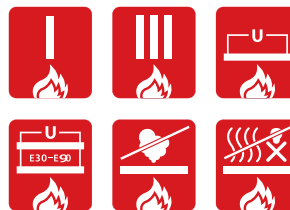
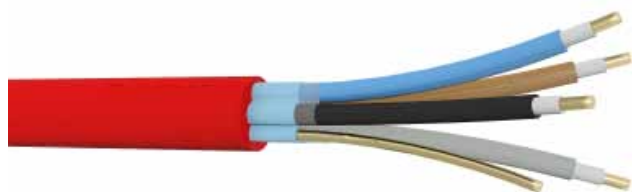

Enhanced grade fire resistant cables having low emission of smoke and corrosive gases when affected by fire

FIRE PERFORMANCE

Fire resistance:	Complies with the PH 120 ENHANCED fire resistant cable described in Clause 26.2 of BS 5839-1:2002 BS 6387 Category C,W,Z BS EN 50200 Class PH 120 BS 8434-2 duration 120 min (60 min for the fire 930°C and impact and 60 min for the fire 930°C, impact and water)
Flame propagation:	BS EN 60332-1-2 and BS EN 50266-2-2
Smoke emission:	BS EN 61034-2
Gases evolved during combustion:	BS EN 50267-2-1: HCL ≤ 0,5%

CONSTRUCTION

Conductors:	plain annealed copper solid class 1 (for 1 – 2,5 mm ²) and stranded class 2 (for 4 mm ²) according to BS EN 60228
Uninsulated circuit protective conductor:	tinned annealed copper of the same nominal cross-sectional area and of the same class as the insulated conductors
Insulation:	glass impregnated mica tape and special cross-linked heat resistant compound type EI2 according to BS EN 50363.1
Optional binder:	non hygroscopic halogen free tape
Screen:	aluminium/polyester laminated tape and uninsulated circuit protective conductor
Outer sheath:	thermoplastic zero halogen low smoke compound type LTS 3 according to BS 7655-6.1

CHARACTERISTIC

Colour of sheath:	red or white (other colours are available on special request)
Core identification:	2 core + ECC: brown, blue 3 core + ECC: brown, blue, grey 4 core + ECC: blue, brown, black, grey
Maximum conductor operating temperature:	+70°C
Lowest temperature ambient for fixed installation:	-30°C
Lowest installation temperature:	0°C
Maximum short-circuit conductor temperature:	+250°C
Minimum bending radius:	6D (D - overall cable diameter)
Application:	for use in Installations emergency lighting and evacuation systems, fire and smoke detection systems air-conditioning and alarm systems, automatic elevator doors, computer control rooms, emergency evacuation communicators. Recommended for systems, in particular building types, in which cables might need to operate correctly during a fire for periods in excess of those normally required for single phase evacuation of a building. Cables meeting the enhanced requirement should be used in buildings greater than 30 m in height, or with four or more evacuation zones, or for example hospitals, where there are progressive horizontal evacuation arrangements, or where a risk assessment identifies a possible need.
Standard packing:	500 m on drums. Other forms of packing and delivery are available on request.

Cable Ref.	Conductor class	Nominal cross-section area of conductor	Nominal cross-sectional area of protective conductor	Approximate overall diameter	Approximate net weight of cable	Maximum conductor resistance at 20°C	Maximum ECC conductor resistance at 20°C
		mm ²	mm ²	mm	kg/km	W/km	W/km
FLAME-X ENH 2x1 + ECC	1	1	1	8,2	78	18,1	18,2
FLAME-X ENH 2x1.5 + ECC	1	1,5	1,5	9,1	99	12,1	12,2
FLAME-X ENH 2x2.5 + ECC	1	2,5	2,5	10,5	141	7,41	7,56
FLAME-X ENH 2x4 + ECC	2	4	4	12,2	201	4,61	4,70
FLAME-X ENH 3x1 + ECC	1	1	1	8,7	98	18,1	18,2
FLAME-X ENH 3x1.5 + ECC	1	1,5	1,5	9,6	125	12,1	12,2
FLAME-X ENH 3x2.5 + ECC	1	2,5	2,5	11,1	179	7,41	7,56
FLAME-X ENH 3x4 + ECC	2	4	4	12,9	256	4,61	4,70
FLAME-X ENH 4x1 + ECC	1	1	1	9,4	119	18,1	18,2
FLAME-X ENH 4x1.5 + ECC	1	1,5	1,5	10,7	155	12,1	12,2
FLAME-X ENH 4x2.5 + ECC	1	2,5	2,5	12,6	224	7,41	7,56
FLAME-X ENH 4x4 + ECC	2	4	4	15,8	327	4,61	4,70



Armoured fire resistant electric power cable having low emission of smoke and corrosive gases when affected by fire

FIRE PERFORMANCE

Fire resistance:	Category F2 according to BS 7846, BS 6387 – Category C,W, Z
Flame propagation:	BS EN 60332-1-2, BS EN 50266-2-4
Low smoke emission:	BS EN 61034-2
Low corrosive and acid gas emission:	EN 50267-2-1, HCL level ≤ 0.5%

CONSTRUCTION

Conductors:	circular, circular compacted or shaped, stranded, annealed copper conductor, class 2 according to BS EN 60228
Primary insulation:	a suitable wrapping of mica tape with a glass cloth
Insulation:	cross-linked polyethylene (XLPE) of GP8 type according to BS 7655-1.3
Bedding:	LSOH (special low smoke zero halogen compound)
Armour:	single layer of galvanized steel wires applied helically over the bedding
Outer sheath:	thermosetting LSOH compound of LTS1 type according to BS 7655-6.1

CHARACTERISTIC

Colour of the sheath:	black. Other colours are available on special request.
Core identification:	
2-core:	brown, blue
3-core:	brown, black, grey
4-core:	blue, brown, black, grey
Maximum conductor operating temperature:	+90°C
Lowest installation temperature:	0°C
Maximum short-circuit conductor temperature:	+250°C
Minimum bending radius:	6D for cables with circular copper conductors and 8D for cables with shaped copper conductors; D – overall cable diameter
Application:	for use in fixed installations in industrial areas, public buildings (as for example power plants, hospitals, shopping centres, theatres) and similar applications where maintenance of power supply during a fire is required for a defined period of time.
Standard packing:	500 m on drums. Other forms of packing and delivery are available on request.

Technical and Electrical Characteristics

Number and CSA of conductor	Nominal thickness of insulation	Nominal thickness of outer sheath	Nominal diameter of armour wires	Approx. overall diameter	Approx. net weight of cables	Maximum conductor resistance at 20°C	Current rating single phase AC or DC		Voltage Drop DC	Voltage Drop single phase AC
							Clipped direct ⁴⁾	Free Air ⁴⁾		
n x mm ²	mm	mm	mm	mm	kg/km	W/km	Amp	Amp	mV/A/m	mV/A/m
2 x 1.5 ¹⁾	0.6	1.3	0.9	13.3	360	12.1	27	29	31.0	31.0
2 x 2.5 ¹⁾	0.7	1.4	0.9	14.8	440	7.41	36	39	19.0	19.0
2 x 4 ¹⁾	0.7	1.4	0.9	15.8	510	4.61	49	52	12.0	12.0
2 x 6 ¹⁾	0.7	1.4	0.9	16.5	580	3.08	62	66	7.9	7.9
2 x 10 ¹⁾	0.7	1.5	0.9	18.6	740	1.83	85	90	4.7	4.7
2 x 16 ¹⁾	0.7	1.5	1.25	21.3	1060	1.15	110	115	2.9	2.9
2 x 25 ¹⁾	0.9	1.6	1.25	25.2	1440	0.727	146	152	1.85	1.90
2 x 25 ²⁾	0.9	1.6	1.25	22.0	1150	0.727	146	152	1.85	1.90
2 x 35 ¹⁾	0.9	1.7	1.6	28.6	1960	0.524	180	188	1.35	1.35
2 x 35 ²⁾	0.9	1.7	1.6	24.8	1570	0.524	180	188	1.35	1.35
2 x 50 ³⁾	1.0	1.8	1.6	27.3	1900	0.387	219	228	0.98	1.00
2 x 70	1.1	1.9	1.6	31.3	2500	0.268	279	291	0.67	0.69
2 x 95	1.1	2.0	2.0	34.2	3350	0.193	338	354	0.49	0.52
2 x 120	1.2	2.1	2.0	37.7	4000	0.153	392	410	0.39	0.42
2 x 150	1.4	2.2	2.0	40.3	4700	0.124	451	472	0.31	0.35
2 x 185	1.6	2.4	2.5	45.1	6000	0.0991	515	539	0.25	0.29
2 x 240	1.7	2.5	2.5	48.7	7300	0.0754	607	636	0.195	0.24
2 X 300	1.8	2.6	2.5	53.3	8700	0.0601	698	732	0.155	0.21

Number and CSA of conductor	Nominal thickness of insulation	Nominal thickness of outer sheath	Nominal diameter of armour wires	Approx. overall diameter	Approx. net weight of cables	Maximum conductor resistance at 20°C	Short circuit current rating	Current rating three phase AC		Voltage Drop Three phase AC
								Clipped direct ⁴⁾	Free Air ⁴⁾	
n x mm ²	mm	Mm	mm	mm	kg/km	W/km	Amp	Amp	Amp	mV/A/m
3 x 1.5 ¹⁾	0.6	1.3	0.9	13.9	390	12.1	210	23	25	27.0
3 x 2.5 ¹⁾	0.7	1.4	0.9	15.5	480	7.41	350	31	33	16.0
3 x 4 ¹⁾	0.7	1.4	0.9	16.6	570	4.61	570	42	44	10.0
3 x 6 ¹⁾	0.7	1.4	0.9	17.4	650	3.08	850	53	56	6.8
3 x 10 ¹⁾	0.7	1.5	1.25	20.2	970	1.83	1400	73	78	4.0
3 x 16 ¹⁾	0.7	1.6	1.25	22.6	1240	1.15	2200	94	99	2.5
3 x 25 ¹⁾	0.9	1.7	1.6	27.9	1920	0.727	3600	124	131	1.65
3 x 25 ²⁾	0.9	1.7	1.6	25.4	1680	0.727	5000	124	131	1.65
3 x 35 ¹⁾	0.9	1.8	1.6	30.4	2330	0.524	6800	154	162	1.15
3 x 35 ²⁾	0.9	1.8	1.6	27.9	2050	0.524	9800	154	162	1.15
3 x 50 ³⁾	1.0	1.8	1.6	30.2	2500	0.387	13600	187	197	0.87
3 x 70	1.1	1.9	1.6	34.1	3300	0.268	17200	238	251	0.60
3 x 95	1.1	2.1	2.0	38.6	4450	0.193	21100	289	304	0.45
3 x 120	1.2	2.2	2.0	41.7	5350	0.153	26500	335	353	0.37
3 x 150	1.4	2.3	2.5	47.1	6850	0.124	34900	386	406	0.30
3 x 185	1.6	2.4	2.5	51.0	8150	0.0991	43700	441	463	0.26
3 x 240	1.7	2.6	2.5	56.0	10100	0.0754	55900	520	546	0.21
3 x 300	1.8	2.7	2.5	60.8	12050	0.0601	70600	599	628	0.185

Number and CSA of conductor	Nominal thickness of insulation	Nominal thickness of outer sheath	Nominal diameter of armour wires	Approx. overall diameter	Approx. net weight of cables	Maximum conductor resistance at 20°C	Short circuit current rating	Current rating three phase AC		Voltage Drop Three phase A
								Clipped direct ⁴⁾	Free Air ⁴⁾	
n x mm ²	mm	mm	mm	mm	kg/km	W/km	Amp	Amp	Amp	mV/A/m
4 x 1.5 ¹⁾	06	1.3	0.9	15.0	445	12.1	210	23	25	27.0
4 x 2.5 ¹⁾	0.7	1.4	0.9	16.7	550	7.41	350	31	33	16.0
4 x 4 ¹⁾	0.7	1.4	0.9	17.9	650	4.61	570	42	44	10.0
4 x 6 ¹⁾	0.7	1.5	1.25	19.7	880	3.08	850	53	56	6.8
4 x 10 ¹⁾	0.7	1.5	1.25	21.9	1130	1.83	1400	73	78	4.0
4 x 16 ¹⁾	0.7	1.6	1.25	24.6	1470	1.15	2200	94	99	2.5
4 x 25 ¹⁾	0.9	1.7	1.6	30.3	2250	0.727	3600	124	131	1.65
4 x 25 ²⁾	0.9	1.7	1.6	28.1	2050	0.727	5000	124	131	1.65
4 x 35 ¹⁾	0.9	1.8	1.6	33.0	2750	0.524	6800	154	162	1.15
4 x 35 ²⁾	0.9	1.8	1.6	30.8	2550	0.524	9800	154	162	1.15
4 x 50 ³⁾	1.0	1.9	1.6	33.8	3150	0.387	13600	187	197	0.87
4 x 70	1.1	2.1	2.0	39.5	4450	0.268	17200	238	251	0.60
4 x 95	1.1	2.2	2.0	43.2	5650	0.193	21100	289	304	0.45
4 x 120	1.2	2.3	2.5	48.5	7300	0.153	26500	335	353	0.37
4 x 150	1.4	2.4	2.5	52.5	8600	0.124	34900	386	406	0.30
4 x 185	1.6	2.6	2.5	57.2	10300	0.0991	43700	441	463	0.26
4 x 240	1.7	2.7	2.5	63.0	12900	0.0754	55900	520	546	0.21
4 x 300	1.8	2.9	2.5	68.0	15400	0.0601	70600	599	628	0.185

¹⁾ Circular stranded conductors (class 2).

²⁾ Shaped stranded conductor (class 2).

³⁾ Cables having conductors of nominal cross-sectional area 50 mm² and above have shaped stranded conductors (class 2).

⁴⁾ Installation reference methods as per BS 7671 (IEE Wiring Regulations). Conductor operating temperature 90°C, ambient temperature 30°C.

Single core non-sheathed fire resistant cable having low emission of smoke and corrosive gases when affected by fire



FIRE PERFORMANCE

Fire resistance:	IEC 60331-21, tested at 950°C and BS 6387 category C, W, Z ¹⁾
Flame propagation:	EN 60332-1-2
Smoke emission:	EN 61034-2
Corrosive and acid gas emission:	EN 50267-2-1, HCl ≤ 0.5 %

CONSTRUCTION

Conductors:	circular or compacted circular, stranded, annealed copper conductor, class 2 according to BS EN 60228
Primary insulation:	a suitable wrapping of mica tape with a glass cloth
Insulation:	special thermosetting LSOH compound of EI5 type according to BS EN 50363-5

CHARACTERISTIC

Core identification:	green/yellow, blue, black, brown, grey, red, yellow. Other colours are available on special request.
Application:	for use in fixed installations, where cable is protected by conduit or trunking. Fire resistant cables intended to provide circuit integrity in case of fire.
Standard packing:	100 m in coils or on spools, or 500 m on drums. Other forms of packing and delivery are available on request.

Nominal cross-sectional area of conductor	Radial thickness of insulation	Approximate overall diameter	Approximate net weight	Maximum resistance of conductor at temperature 20°C
mm ²	mm	mm	kg/km	W/km
1,5	0,7	3,6	24	12,1
2,5	0,8	4,2	36	7,41
4	0,8	4,7	51	4,61
6	0,8	5,1	69	3,08
10	1,0	6,4	114	1,83
16	1,0	7,4	170	1,15
25	1,2	9,7	269	0,727
35	1,2	10,8	360	0,524
50	1,4	12,5	489	0,387
70	1,4	13,8	681	0,268

1) To satisfy the requirement of BS 6387, testing for categories C, W, and Z was conducted in steel conduit as other metallic element. Cat. C, W, Z for cables up to and including 95mm², cat. C only for cables 120 – 400 mm².

Nominal cross-sectional area of conductor	Radial thickness of insulation	Approximate overall diameter	Approximate net weight	Maximum resistance of conductor at temperature 20°C
mm ²	mm	mm	kg/km	W/km
95	1,6	16,2	940	0,193
120	1,6	17,6	1168	0,153
150	1,8	19,6	1442	0,124
185	2,0	21,5	1797	0,0991
240	2,2	25,5	2339	0,0754
300	2,4	28,3	2909	0,0601
400	2,6	31,6	3698	0,0470
500	2,8	35,3	4719	0,0366

Nominal cross-sectional area of conductor	Short circuit current ratings (1 sec)	Current Rating*Two cables, single phase AC or DC	Current Rating*Three or four cables, three phase AC	Voltage Drop** Two cables DC	Voltage Drop** Two cables, single phase AC	Voltage Drop** Three or four cables, three phase A.C
mm ²	Amps	Amps	Amps	mV/A/m	mV/A/m	mV/A/m
1.5	210	22	19	31	31	27
2.5	350	30	26	19	19	16
4	570	40	35	12	12	10
6	850	51	45	7.9	7.9	6.8
10	1400	71	63	4.7	4.7	4.0
16	2200	95	85	2.9	2.9	2.5
25	3600	126	111	1.85	1.90	1.65
35	5000	156	138	1.35	1.35	1.15
50	6800	189	168	0.99	1.05	0.90
70	9800	240	214	0.68	0.75	0.65
95	13600	290	259	0.49	0.58	0.50
120	17200	336	299	0.39	0.48	0.42
150	21100	375	328	0.32	0.43	0.37
185	26500	426	370	0.25	0.37	0.32
240	34900	500	433	0.190	0.33	0.29
300	43700	573	493	0.155	0.31	0.27
400	55900	683	584	0.120	0.29	0.25
500	70600	783	666	0.093	0.28	0.24

* Installation reference method 3 (enclosed in conduit on a wall or in trunking etc.) as per BS 7671, Appendix 4. Conductor operating temperature 90°C, ambient temperature 30°C.

** Installation reference methods 3 and 4 (enclosed in conduit, etc. in or on a wall) as per BS 7671, Appendix 4. Conductor operating temperature 90°C, ambient temperature 30°C.

Facing the energy challenge



**Flexible
fire resistant
power & control
cables**

FIRE PERFORMANCE

Flame retardant:	AS/NZS 1660.5.1; IEC 60332-3-22 Cat. A; IEC 60332-1
Cable circuit integrity:	AS/NZS 1660.5.5; IEC 60331; BS 6387, Cat. C,W,Z
Wiring system circuit integrity:	AS/NZS 3013, Cat. WS52W
Smoke density:	AS/NZS 1660.5.2; IEC 61034-2
Halogen acid gas content:	AS/NZS 1660.5.3, IEC 60754-1
Gases evolved during combustion:	AS/NZS 1660.5.4, IEC 60754-2

CONSTRUCTION

Conductors:	Flexible bare copper wire stranding; class 5 according to IEC 60228 and AS/NZS 1125
Flame Barrier:	Glass mica tape
Insulation:	Cross-linked, halogen-free, flame retardant compound type X-HF-110 acc. to AS/NZS 3808
Sheath:	Flexible, thermoplastic, low smoke, halogen-free compound having reduced flame propagation when exposed to a fire, type HFS-110-TP acc. to AS/NZS 3808

CHARACTERISTIC

Colour of sheath:	Red RAL 3000. Other colours are available on special request.
Core identification:	the colouring for identification may be within the mass not at the surface of the core insulation 1-core: red or green-yellow 2-core: red, white 2-core + earth: red, black, green-yellow 3-core + earth: red, white, blue, green-yellow 4-core + earth: red, white, blue, black, green-yellow 6-core + earth: green-yellow, others cores white with black numbers
Maximum continuous operating temperature:	110°C
Flexibility for easy of installation	
Minimum bending radius:	8D (D – overall cable diameter)
Application:	Mica and cross-linked halogen-free flame retardant insulated and halogen-free thermoplastic compound sheathed flexible, enhanced fire resistant cables for use in installations emergency lighting and evacuation systems, fire and smoke detection systems air-conditioning and alarm systems, automatic elevator doors, computer control rooms, emergency evacuation communicators. Recommended for systems, in particular building types, in which cables might need to operate correctly during a fire for periods in excess of those normally required for single phase evacuation of a building.
Standard length cable packing:	500 or 1000m on drums. Other forms of packing and delivery are available on request.

Number and cross-sectional area of conductor	Nominal thickness of insulation	Approx Diameter over insulation	Nominal thickness of sheath	Approximate overall diameter	Approximate net weight of cables	Cable combustion heat
n x mm ²	mm	mm	mm	mm	kg/km	kW/km
1x6	0.7	5.4	1.4	8.2	109	0.37
1x10	0.7	6.3	1.4	9.1	153	0.42
1x16	0.7	7.5	1.4	10.3	215	0.49
1x25	0.9	9.1	1.4	11.9	311	0.66
1x35	0.9	9.9	1.4	12.7	403	0.72
1x50	1.0	12.1	1.4	14.9	558	0.91
1x70	1.1	14.1	1.4	16.9	761	1.11
1x95	1.1	16.2	1.5	19.2	983	1.32
1x120	1.2	17.5	1.5	20.5	1222	1.49
1x150	1.4	19.8	1.6	23	1522	1.87
1x185	1.6	22.4	1.7	25.8	1855	2.33
1x240	1.7	24.1	1.7	27.5	2365	2.58
1x300	1.8	27.9	1.8	31.5	2945	3.18
1x400	2	30.3	1.9	34.1	3810	3.73
1x500	2.2	35.3	2	39.3	4811	4.69
1x630	2.4	40.0	2.2	44.4	6366	5.83
2x0.75	0.7	3.5	1.8	10.5	131	0.73
2x1.0	0.7	3.6	1.8	10.7	139	0.75
2x1.5	0.7	3.9	1.8	11.3	160	0.79
2x2.5	0.7	4.3	1.8	12.3	197	0.91
2x4	0.7	4.8	1.8	13.2	241	1.03
3x0.75	0.7	3.5	1.8	11.1	149	0.80
3x1.0	0.7	3.6	1.8	11.2	158	0.82
2x1.5+1.5E	0.7	3.9	1.8	11.2	171	0.82
2x2.5+2.5E	0.7	4.3	1.8	12.3	217	0.95
2x4+2.5E	0.7	4.8	1.8	12.9	257	1.04
2x4+4E	0.7	4.8	1.8	13.3	273	1.07
2x6+2.5E	0.7	5.4	1.8	13.8	312	1.17
2x10+4E	0.7	6.3	1.8	15.4	433	1.41
2x10+10E	0.7	6.3	1.8	16.5	497	1.50
2x16+6E	0.7	7.5	1.8	17.5	605	1.75
2x16+16E	0.7	7.5	1.8	19	706	1.87
2x25+6E	0.9	9.1	1.8	19.9	849	2.37
2x35+10E	0.9	9.9	1.8	21.6	1098	2.66
2x50+16E	1.0	12.1	1.8	25.6	1554	3.61
2x70+25E	1.1	14.1	1.8	29.7	2147	4.71
2x95+25E	1.1	16.2	1.9	32.9	2701	5.75
2x120+35E	1.2	17.5	2	35.4	3362	6.65
2x150+50E	1.4	19.8	2.1	40.5	4263	8.44
2x185+70E	1.6	22.4	2.2	45.9	5326	10.67
2x240+95E	1.7	24.1	2.4	50.2	6745	12.41

054

Number and cross-sectional area of conductor	Nominal thickness of insulation	Approx Diameter over insulation	Nominal thickness of sheath	Approximate overall diameter	Approximate net weight of cables	Cable combustion Heat
n x mm ²	mm	mm	mm	mm	kg/km	kW/km
4x0.75	0.7	3.5	1.8	12	173	0.91
4x1.0	0.7	3.6	1.8	12.2	185	0.93
3x1.5+1.5E	0.7	3.9	1.8	12.3	205	0.96
3x2.5+2.5E	0.7	4.3	1.8	13.5	262	1.11
3x4+4E	0.7	4.8	1.8	14.6	333	1.25

Number and cross-sectional area of conductor	Nominal thickness of insulation	Approx Diameter over insulation	Nominal thickness of sheath	Approximate overall diameter	Approximate net weight of cables	Cable combustion Heat
n x mm ²	mm	mm	mm	mm	kg/km	kW/km
3x6+6E	0.7	5.4	1.8	16	429	1.44
3x10+10E	0.7	6.3	1.8	18.3	618	1.77
3x16+16E	0.7	7.5	1.8	21	884	2.18
3x25+6E	0.9	9.1	1.8	22.8	1121	2.85
3x35+10E	0.9	9.9	1.8	24.7	1459	3.19
3x50+16E	1.0	12.1	1.8	29.4	2063	4.31
3x70+25E	1.1	14.1	1.9	34.2	2867	5.67
3x95+25E	1.1	16.2	2	38.2	3635	6.91
3x120+35E	1.2	17.5	2.1	41.2	4536	8.00
3x150+50E	1.4	19.8	2.3	47	5745	10.25
3x185+70E	1.6	22.4	2.4	53.1	7129	12.93
3x240+95E	1.7	24.1	2.6	57.9	9065	14.98
3x300+120E	1.8	27.9	2.8	66	11423	19.15
4x1.5+1.5E	0.7	3.9	1.8	13.5	243	1.13
4x2.5+2.5E	0.7	4.3	1.8	14.8	310	1.29
4x4+4E	0.7	4.8	1.8	16.1	398	1.48
4x6+6E	0.7	5.4	1.8	17.6	514	1.70
4x10+10E	0.7	6.3	1.8	20.1	746	2.07
4x16+16E	0.7	7.5	1.8	23.2	1073	2.58
4x25+6E	0.9	9.1	1.8	25.7	1407	3.46
4x35+10E	0.9	9.9	1.8	27.8	1836	3.86
4x50+16E	1.0	12.1	1.9	33.4	2612	5.31
4x70+25E	1.1	14.1	2	38.8	3627	6.98
4x95+25E	1.1	16.2	2.1	43.6	4618	8.50
4x120+35E	1.2	17.5	2.3	47.1	5786	9.94
4x150+50E	1.4	19.8	2.4	53.4	7281	12.58
4x185+70E	1.6	22.4	2.6	60.5	9032	16.02
6x1.5+1.5E	0.7	3.9	1.8	14.9	275	1.17
6x2.5+2.5E	0.7	4.3	1.8	16.3	356	1.33
11x1.5+1.5E	0.7	3.9	1.8	19.4	435	1.78
20x1.5+1.5E	0.7	3.9	1.8	23.6	700	2.74

TECHNICAL INFORMATION

SINGLE CORE CABLES

Cross-sectional area of conductor	Inductance	Reactance	Impedance
n x mm ²	mH/km	Ohm/km	Ohm/km
6	0.309	0.097	4.558
10	0.283	0.089	2.639
16	0.262	0.082	1.673
25	0.252	0.079	1.080
35	0.245	0.077	0.769
50	0.230	0.072	0.538
70	0.221	0.070	0.382
95	0.214	0.067	0.292
120	0.211	0.066	0.232
150	0.210	0.066	0.190
185	0.207	0.065	0.160
240	0.205	0.064	0.128
300	0.199	0.062	0.108

Cross-sectional area of conductor	Inductance	Reactance	Impedance
$n \times \text{mm}^2$	mH/km	Ohm/km	Ohm/km
400	0.199	0.062	0.092
500	0.195	0.061	0.081
630	0.192	0.060	0.072

MULTICORE CABLES			
Cross-sectional area of conductor	Inductance	Reactance	Impedance
$n \times \text{mm}^2$	mH/km	Ohm/km	Ohm/km
0.75	0.333	0.104	35.900
1.0	0.324	0.102	26.925
1.5	0.301	0.094	18.365
2.5	0.275	0.086	11.019
4	0.258	0.081	6.835
6	0.242	0.076	4.557
10	0.225	0.071	2.638
16	0.211	0.066	1.672
25	0.210	0.066	1.079
35	0.205	0.064	0.768
50	0.197	0.062	0.537
70	0.193	0.061	0.380
95	0.187	0.059	0.290
120	0.186	0.058	0.230
150	0.185	0.058	0.187
185	0.184	0.058	0.157
240	0.183	0.058	0.125
300	0.180	0.056	0.105

TECHNICAL INFORMATION				
Cross-sectional area of conductor	Conductor Dimensions	Conductor Short Circuit Current Rating (for 5s)	Maximum conductor resistance at	
mm^2	mm	A	20°C	110°C
			W/km	W/km
0.75	1.10	48	26	35.9
1.0	1.19	64	19.5	26.9
1.5	1.50	96	13.3	18.4
2.5	1.98	160	7.98	11.02
4	2.45	256	4.95	6.83
6	3.03	384	3.30	4.56
10	3.95	640	1.91	2.64
16	5.10	1023	1.21	1.67
25	6.27	1599	0.780	1.08
35	7.00	2238	0.554	0.765
50	9.00	3198	0.386	0.533
70	10.80	4477	0.272	0.376
95	12.90	6075	0.206	0.284
120	13.97	7674	0.161	0.222
150	15.84	9593	0.129	0.178
185	18.06	11831	0.106	0.146
240	19.55	15348	0.0801	0.1106
300	23.22	19185	0.0641	0.0885
400	25.14	25581	0.0486	0.0671
500	29.74	31976	0.0384	0.0530
630	34.08	40289	0.0287	0.0396

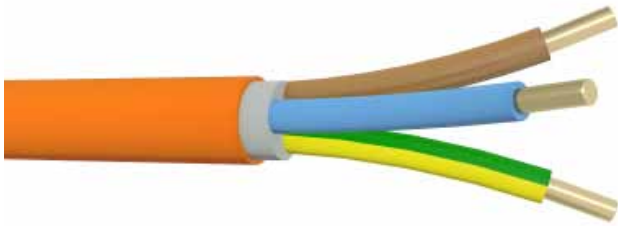

Halogen-free low smoke fire resistant security power cables

FIRE PERFORMANCE

Fire resistance:	rated CR1 according to NFC 32-070, voltage: 300/500V IEC 60331-21 (180 min) and EN 50200 PH 90
Flame propagation:	rated C1 according to NFC 32-070, EN 50266-2-2, IEC 60332-3 -22 rated C2 according to NFC 32-070, EN 60332-1-2, IEC 60332-1-2
Smoke density:	IEC 61034-2
Halogen free, non toxic or corrosive gases:	IEC 60754-2: pH ≥ 4,3; conductivity ≤ 2,5 μS/mm

CONSTRUCTION

Conductors:	bare copper conductor, for 1,5 – 4 mm ² circular solid class 1 or for ≥ 6 mm ² stranded circular compacted class 2 according to EN 60228
Insulation:	special cross-linked halogen-free fire resistant silicone compound type EI2 according to EN 50363-1
Inner covering:	special flame-retardant and halogen-free compound (for multicore cables ≥ 16 mm ²)
Sheath:	thermoplastic halogen-free polyolefin compound type HM4 according to HD 604 S1

CHARACTERISTIC

Core identification:	according to NFC 32-081 / HD 308 S2 or EN 50334	
	without protective conductor	with protective conductor
1-core:	black	green-yellow
2-core:	blue, brown	—
3-core:	brown, black, grey	green-yellow, blue, brown
4-core:	blue, brown, black, grey	green-yellow, brown, black, grey
5-core:	blue, brown, black, grey, black	green-yellow, blue, brown, black, grey
≥ 7-core:	black with numbering	green-yellow, others cores black with numbering
Nominal voltage:	300/500V	
Maximum conductor operating temperature:	+90°C	
Lowest ambient temperature for fixed installation:	-30°C	
Lowest installation temperature:	-5°C	
Maximum short-circuit conductor temperature:	+250°C	
Minimum bending radius:	15D - for single core cable; 12D - for multicore cable (D - overall cable diameter)	
Maximum permissible tensile stress with cable grip for Cu-conductor:	50 N/mm ²	
Application:	Fire resistant security cables for installation everywhere where high safety requirements have a special significance e.g., in industrial complexes, power stations, public buildings, hotels, underground railway systems, hospitals etc.	
Standard packing:	500 m on drums. Other forms of packing and delivery are available on request.	

Number and cross-sectional area of conductor	Approximate overall diameter	Approximate net weight of cables	Maximum conductor resistance at 20°C
n x mm ²	mm	kg/km	W/km
1 x 1,5	5,8	49	12,1
1 x 2,5	5,9	58	7,41
1 x 4	6,4	75	4,61
1 x 6	7,3	102	3,08
1 x 10	8,2	146	1,83
1 x 16	9,2	207	1,15
1 x 25	10,9	308	0,727
1 x 35	12,0	404	0,524
1 x 50	13,7	537	0,387
1 x 70	15,0	735	0,268
1 x 95	17,6	1011	0,193
1 x 120	19,0	1243	0,153
1 x 150	21,2	1533	0,124
1 x 185	23,3	1905	0,0991
1 x 240	26,4	2464	0,0754
1 x 300	28,8	3067	0,0601
2 x 1,5	9,1	98	12,1
2 x 2,5	10,3	129	7,41
2 x 4	11,2	164	4,61
2 x 6	12,9	221	3,08
2 x 10	14,8	313	1,83
2 x 16	17,6	611	1,15
2 x 25	21,2	917	0,727
3 x 1,5	9,6	122	12,1
3 x 2,5	10,8	163	7,41
3 x 4	11,8	214	4,61
3 x 6	13,7	294	3,08
3 x 10	15,7	426	1,83
3 x 16	18,8	766	1,15
3 x 25	22,5	1142	0,727
3 x 35	24,8	1481	0,524
3 x 50	28,4	1973	0,387
3 x 70	31,9	2700	0,268
3 x 95	37,2	3693	0,193
4 x 1,5	10,3	148	12,1
4 x 2,5	11,7	202	7,41
4 x 4	12,9	269	4,61
4 x 6	15,0	374	3,08
4 x 10	17,2	548	1,83
4 x 16	21,4	997	1,15
4 x 25	25,5	1481	0,727
4 x 35	28,1	1922	0,524
4 x 50	31,8	2522	0,387
4 x 70	35,4	3435	0,268
4 x 95	41,2	4702	0,193
5 x 1,5	11,2	178	12,1
5 x 2,5	12,8	246	7,41
5 x 4	14,0	328	4,61
5 x 6	16,3	460	3,08
5 x 10	19,2	697	1,83
5 x 16	23,4	1205	1,15
5 x 25	28,0	1800	0,727

Number and cross-sectional area of conductor		Approximate overall diameter	Approximate net weight of cables	Maximum conductor resistance at 20°C
n x mm ²		mm	kg/km	W/km
5	x 35	30,8	2341	0,524
5	x 50	35,4	3122	0,387
5	x 70	39,3	4250	0,268
5	x 95	46,1	5841	0,193
7	x 1,5	12,1	219	12,1
7	x 2,5	13,8	307	7,41
10	x 1,5	15,0	301	12,1
10	x 2,5	17,4	427	7,41
12	x 1,5	14,7	316	12,1
12	x 2,5	17,1	459	7,41
14	x 1,5	16,3	390	12,1
14	x 2,5	18,8	559	7,41
16	x 1,5	17,1	440	12,1
16	x 2,5	19,8	635	7,41
19	x 1,5	17,8	493	12,1
19	x 2,5	20,9	727	7,41
24	x 1,5	21,0	624	12,1
24	x 2,5	24,4	908	7,41
27	x 1,5	21,4	685	12,1
27	x 2,5	25,0	1003	7,41
30	x 1,5	22,2	751	12,1
30	x 2,5	25,9	1102	7,41
37	x 1,5	23,9	902	12,1
37	x 2,5	28,2	1344	7,41

Halogen-free low smoke fire resistant cables

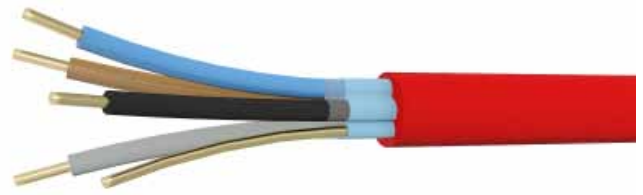
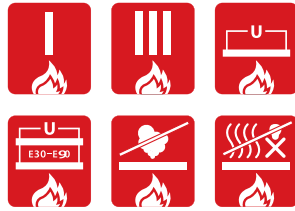

FIRE PERFORMANCE

Fire resistance:	IEC 60331: 3h at 750°C EN 50200 – PH 90 (for cables with overall diameter ≤ 20 mm) BS 6387 Category C – resistance to fire: 3 h at 950°C Category W – resistance to fire with water: 15 min at 650°C plus 15 min with water spray Category Z – resistance to fire with mechanical shock: 15 min at 950°C
Flame propagation:	IEC 60332-3-22 Category A, (EN 50266-2-2)
Smoke emission:	IEC 61034-2, BS EN 61034-2:
Gases evolved during combustion:	IEC 60754-1, EN 50267-2-1: < 0,5% acid gas IEC 60754-2, EN 50267-2-2: pH ≥ 4,3; conductivity ≤ 10 μSmm ⁻¹

TYPE OF FLAME-X 950 CABLES:

HDGs	cable with solid copper conductors (D), special cross-linked silicone compound insulation (Gs) and thermoplastic halogen-free outer sheath (H)
HLGs	cable with stranded copper conductors (L), special cross-linked silicone compound insulation (Gs) and thermoplastic halogen-free outer sheath (H)
HLgGs	cable with stranded flexible copper conductors (Lg), special cross-linked silicone compound insulation (Gs) and thermoplastic halogen-free outer sheath (H)
HDGsekwf	cable with solid copper conductors (D), special cross-linked silicone compound insulation (Gs) and thermoplastic halogen-free outer sheath (H), with electrostatic screen of aluminium/polyester laminated tape (ekwf)
HLGsekwf	cable with stranded copper conductors (L), special cross-linked silicone compound insulation (Gs) and thermoplastic halogen-free outer sheath (H), with electrostatic screen of aluminium/polyester laminated tape (ekwf)
HLgGsekwf	cable with stranded flexible copper conductors (Lg), special cross-linked silicone compound insulation (Gs) and thermoplastic halogen-free outer sheath (H), with electrostatic screen of aluminium/polyester laminated tape (ekwf)

CONSTRUCTION

Conductors:	circular copper class 1 (D), circular stranded copper class 2 (L) or circular flexible stranded copper class 5 (Lg) according to EN 60228
Drain wire:	tinned annealed copper wires class 1 or stranded class 2 according to EN 60228
Insulation:	special cross-linked heat resistant compound type EI2 FR (Gs) according to EN 50363.1
Optional binder:	non hygroscopic halogen free tape
Screen:	aluminium/polyester laminated tape and drain wire (ekwf)
Outer sheath:	thermoplastic zero halogen low smoke compound (H) according to ZN-TF-208

CHARACTERISTIC

Colour of sheath:	red
Core identification:	≤ 5 core: according to HD 308 S2

CHARACTERISTIC

	without protective conductor	with protective conductor
≥ 7 core:	in each layer: brown (starting core), blue (reference core), other cores natural	in outer layer: green-yellow, blue (reference core), others cores shall be natural, in other layers: brown (starting core), blue (reference core), other cores natural
Maximum conductor operating temperature:	+90°C	
Lowest temperature ambient for fixed installation:	-25°C	
Lowest installation temperature:	-10°C	
Maximum short-circuit conductor temperature:	+250°C	
Minimum bending radius:	6 D (D is the overall diameter of the cable)	
Application:	Installations emergency lighting and evacuation systems, fire and smoke detection systems air-conditioning and alarm systems, automatic elevator doors, computer control rooms, offshore and marine emergency systems, emergency evacuation communicators.	
Standard packing:	500 m on drums. Other forms of packing and delivery are available on request.	

Number and cross-sectional area of conductor			Approximate overall diameter			Approximate net weight of cables		
			HDGs	HLGs	HLgGs	HDGs	HLGs	HLgGs
n x mm ²			mm			kg/km		
2	x	1	6,4	6,9	6,8	50	54	52
2	x	1,5	7,5	8,1	8,0	69	75	72
2	x	2,5	8,9	9,6	9,6	100	109	105
2	x	4	9,8	10,6	10,5	133	144	137
3	x	1	6,8	7,3	7,2	64	70	67
3	x	1,5	7,9	8,6	8,5	90	98	93
3	x	2,5	9,4	10,1	10,1	132	143	137
3	x	4	10,6	11,5	11,3	185	200	189
4	x	1	7,6	8,2	8,0	83	91	86
4	x	1,5	8,9	9,6	9,4	117	127	120
4	x	2,5	10,5	11,3	11,3	171	186	178
4	x	4	11,6	12,6	12,4	235	254	239
5	x	1	8,6	9,3	9,1	109	119	113
5	x	1,5	9,8	10,6	10,4	147	160	152
5	x	2,5	11,6	12,5	12,5	216	235	225
5	x	4	12,8	13,9	13,7	297	321	303
7	x	1	9,3	10,1	9,8	135	148	140
7	x	1,5	10,8	11,7	11,5	190	206	195
7	x	2,5	12,6	13,6	13,6	274	298	284
10	x	1	11,8	12,8	12,5	192	211	199
10	x	1,5	13,6	14,8	14,5	263	287	270
10	x	2,5	16,5	17,9	17,9	407	441	421
12	x	1	12,1	13,2	12,9	220	241	228
12	x	1,5	14,0	15,3	15,0	303	331	311
12	x	2,5	17,0	18,5	18,4	470	510	486
16	x	1	13,4	14,6	14,2	282	310	292
16	x	1,5	16,1	17,5	17,2	415	453	427

Number and cross-sectional area of conductor			Approximate overall diameter			Approximate net weight of cables		
			HDGs	HLGs	HLgGs	HDGs	HLGs	HLgGs
n x mm ²			mm			kg/km		
16	x	2,5	19,4	21,1	21,0	635	690	659
20	x	1	15,4	16,8	16,3	361	395	373
20	x	1,5	18,4	20,0	19,6	524	571	539
20	x	2,5	21,4	23,3	23,2	765	830	791
24	x	1	17,0	18,6	18,1	424	466	439
24	x	1,5	20,3	22,1	21,7	618	673	634
24	x	2,5	24,4	26,5	26,4	939	1019	972
30	x	1	18,6	20,2	19,7	535	587	553
30	x	1,5	21,4	23,4	23,0	742	808	760
30	x	2,5	25,8	28,0	27,9	1132	1228	1168
37	x	1	19,9	21,7	21,2	638	699	659
37	x	1,5	23,7	25,8	25,3	922	1004	945
37	x	2,5	27,7	30,2	30,1	1360	1476	1402

Number and cross-sectional area of conductor			Approximate overall diameter			Approximate net weight of cables		
			HDGsekwf	HLGsekwf	HLgGsekwf	HDGsekwf	HLGsekwf	HLgGsekwf
n x mm ²			mm			kg/km		
2	x	1	7,1	7,4	7,3	65	68	65
2	x	1,5	8,2	8,6	8,5	90	94	89
2	x	2,5	9,6	10,1	10,1	130	137	131
2	x	4	10,5	11,1	11,0	177	186	176
3	x	1	7,5	7,9	7,7	81	85	81
3	x	1,5	8,7	9,1	9,0	113	118	112
3	x	2,5	10,1	10,7	10,7	165	174	166
3	x	4	11,3	12,0	11,9	232	244	230
4	x	1	8,5	9,0	8,7	103	109	103
4	x	1,5	9,9	10,6	10,4	143	152	143
4	x	2,5	11,9	12,8	12,8	211	224	214
4	x	4	13,6	14,8	14,6	291	310	291
5	x	1	10,4	10,8	10,6	132	139	129
5	x	1,5	11,6	12,1	12,0	171	181	169
5	x	2,5	13,4	14,0	14,0	244	258	245
5	x	4	14,6	15,4	15,3	326	346	323
7	x	1	11,2	11,7	11,4	161	169	158
7	x	1,5	12,7	13,3	13,1	219	230	215
7	x	2,5	14,5	15,2	15,2	306	324	306
10	x	1	14,0	14,6	14,3	226	238	222
10	x	1,5	15,8	16,6	16,3	300	316	296
10	x	2,5	18,7	19,7	19,7	450	476	453
12	x	1	14,4	15,0	14,7	257	271	253
12	x	1,5	16,3	17,1	16,8	344	363	340
12	x	2,5	19,3	20,3	20,3	518	548	521

Number and cross-sectional area of conductor			Approximate overall diameter			Approximate net weight of cables		
			HDGsekwf	HLGsekwf	HLgGsekwf	HDGsekwf	HLGsekwf	HLgGsekwf
n x mm ²			mm			kg/km		
16	x	1	15,8	16,6	16,2	327	346	324
16	x	1,5	18,5	19,5	19,2	468	495	465
16	x	2,5	21,8	23,0	23,0	698	740	705
20	x	1	18,0	18,8	18,4	416	439	412
20	x	1,5	21,0	22,0	21,7	589	622	585
20	x	2,5	24,0	25,4	25,3	838	887	844
24	x	1	19,8	20,8	20,3	488	515	483
24	x	1,5	23,1	24,3	23,9	692	730	687
24	x	2,5	27,2	28,7	28,6	1027	1087	1036
30	x	1	21,5	22,5	22,0	612	646	608
30	x	1,5	24,4	25,6	25,3	828	874	822
30	x	2,5	28,7	30,3	30,2	1233	1306	1243
37	x	1	23,0	24,1	23,6	727	768	722
37	x	1,5	26,8	28,2	27,7	1027	1084	1021
37	x	2,5	30,8	32,6	32,5	1479	1566	1489

We bring
the energy



FLAMEBLOCKER

CHAPTER 2

FlameBlocker N2XH 0,6/1 kV	72	FlameBlocker UK REF. 318(*)B 300/500V	101
FlameBlocker (N)2XH FE180 0,6/1 kV]	77	FlameBlocker FR-N1X1G1-U 0,6/1 kV	103
FlameBlocker N2XCH 0,6/1 kV	79	FlameBlocker CU/XLPE/LSOH/AWA/LSOH	
FlameBlocker (N)2XCH FE180 0,6/1 kV	81	FlameBlocker CU/XLPE/LSOH/SWA/LSOH 0,6/1kV	105
FlameBlocker NHXMH 300/500V	84	FlameBlocker MMJ HF 450/750 V	109
FlameBlocker (N)HXMH(St) 300/500V	86	FlameBlocker EQQ LIGHT 300/500 V	111
FlameBlocker H07Z-U, H07Z-R, H07Z-K 450/750V	89	FlameBlocker EXQJ 0,6/1 kV	113
FlameBlocker H07ZZ-F 450/750V	91	FlameBlocker FXQJ 0,6/1 kV	115
FlameBlocker H05Z1Z1-F 300/500V	94	FlameBlocker AXQJ 0,6/1 kV	117
FlameBlocker UK REF. 6181B 450/750V	96	FlameBlocker NSHXAFÖU 1,8/3 kV	120
FlameBlocker UK REF. 6181 XB XLPE/LSF 0,6/1kV	98	FlameBlocker NSHXAFÖU POWER CABLE 3,6/6 kV	122
FlameBlocker UK REF. 624(*)B 300/500V	99		

Flame Retardant, Low Fire Hazard, Halogen Free, Low Smoke Cables and Wires

Cables are manufactured with the use of halogen-free materials. These materials exhibit better fire performance, have improved resistance to flame propagation and can extinguish flame spread through the cable.

Application:

Halogen-free cables are used for applications in public buildings, where fire would present a significant hazard to human life as a result of emission of toxic gasses and dense smoke hampering the evacuation or when the losses caused by the corrosive acid gasses would be higher than other damage caused by fire.

Locations of increased fire safety requirements, where large agglomeration of people and cultural or material goods of high value are present: schools, hospitals, shopping centers, airports, hotels, supermarkets, underground tunnels, multi-storey buildings, stations of underground railways, underground garages, sports and show halls, stadiums, cinemas, theatres, museums, office buildings, educational centers, industrial complexes.

Tested and approved by:

VDE (Verband der Elektrotechnik)
BASEC (British Approvals Service For Cables)
BBJ (Biuro Badawcze ds. Jakości) - Znak Bezpieczeństwa „B”
GOST (Госстандарт)

Halogen-free low smoke power cables

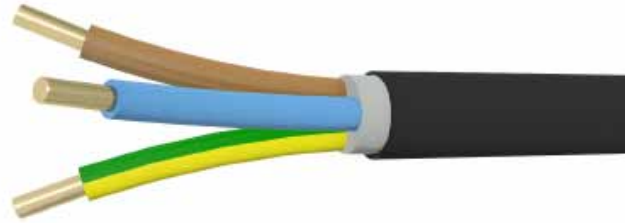

FIRE PERFORMANCE

Flame propagation:	DIN EN 50266-2-4, VDE 0482-266-2-4, IEC 60332-3-24
Smoke density:	DIN EN 61034-2, VDE 0482-1034-2, IEC 61034-2
Gases evolved during combustion:	DIN EN 50267-2-2, VDE 0482-267-2-2, IEC 60754-2: pH ≥ 4,3; conductivity ≤ 2,5 μS/mm

CONSTRUCTION

Conductors:	bare annealed copper conductor, circular solid class 1 (RE) or circular or circular compacted stranded class 2 (RM) or stranded sector - shaped conductor class 2 (SM) according to EN 60228
Insulation:	cross-linked polyethylene type 2X11 according to DIN VDE 0276-604
Inner covering:	special flame-retardant and halogen-free compound
Sheath:	thermoplastic halogen - free compound type HM4 according to DIN VDE 0276-604

CHARACTERISTIC

Colour of sheath:	black, blue, green
Core identification:	according to HD 308 S2 or EN 50334

	N2XH-0 without protective conductor	N2XH-J with protective conductor
1-core:	black	green-yellow
2-core:	blue, brown	—
3-core:	brown, black, grey	green-yellow, blue, brown
3 core:*	blue, brown, black	—
4-core:	blue, brown, black, grey	green-yellow, brown, black, grey
4-core:*	—	green-yellow, blue, brown, black
5-core:	blue, brown, black, grey, black	green-yellow, blue, brown, black, grey
more 5-core:	black with numbering	green-yellow, others cores black with numbering

*For certain applications only

Maximum conductor operating temperature:	+90°C
Lowest ambient temperature for fixed installation:	-30°C
Lowest installation temperature:	-5°C
Maximum short-circuit conductor temperature:	+250°C
Minimum bending radius:	15D - for single core cable; 12D - for multicore cables (D - overall cable diameter)
Maximum permissible tensile stress with cable grip for Cu-conductor:	50 N/mm ²

Application: for the supply of electrical energy, particularly for installations where fire and emissions of smoke and toxic fumes create a potential threat. Not suitable for use in ground and water.

Standard packing: 500 m or 1000m on drums. Other forms of packing and delivery are available on request.

Number and cross-sectional area of conductor			Nominal thickness of insulation	Nominal thickness of sheath	Approximate overall diameter	Approximate net weight of cables	Maximum conductor resistance at 20°C
n x mm ²			mm	mm	mm	kg/km	W/km
1	x	1,5RE	0,7	1,2	5,2	40	12,1
1	x	1,5RM	0,7	1,2	5,4	42	12,1
1	x	2,5RE	0,7	1,2	5,5	51	7,41
1	x	2,5RM	0,7	1,2	5,8	54	7,41
1	x	4RE	0,7	1,2	6,0	67	4,61
1	x	4RM	0,7	1,2	6,3	71	4,61
1	x	6RE	0,7	1,2	6,5	88	3,08
1	x	6RM	0,7	1,2	6,7	90	3,08
1	x	10RE	0,7	1,2	7,3	128	1,83
1	x	10RM	0,7	1,2	7,6	132	1,83
1	x	16RE	0,7	1,2	8,2	185	1,15
1	x	16RM	0,7	1,2	8,6	191	1,15
1	x	25RM	0,9	1,2	10,3	291	0,727
1	x	35RM	0,9	1,2	11,4	385	0,524
1	x	50RM	1,0	1,2	12,9	509	0,387
1	x	70RM	1,1	1,2	14,4	709	0,268
1	x	95RM	1,1	1,3	16,6	966	0,193
1	x	120RM	1,2	1,3	18,2	1201	0,153
1	x	150RM	1,4	1,3	20,2	1474	0,124
1	x	185RM	1,6	1,4	22,3	1837	0,0991
1	x	240RM	1,7	1,4	25,0	2365	0,0754
1	x	300RM	1,8	1,5	27,2	2946	0,0601
1	x	400RM	2,0	1,5	31,2	3797	0,0470
1	x	500RM	2,2	1,6	34,9	4874	0,0366
2	x	1,5RE	0,7	1,2	8,9	118	12,1
2	x	1,5RM	0,7	1,2	9,3	127	12,1
2	x	2,5RE	0,7	1,2	9,7	150	7,41
2	x	2,5RM	0,7	1,2	10,2	161	7,41
2	x	4RE	0,7	1,2	10,6	194	4,61
2	x	4RM	0,7	1,2	11,2	210	4,61
2	x	6RE	0,7	1,2	11,6	249	3,08
2	x	6RM	0,7	1,2	11,9	259	3,08
2	x	10RE	0,7	1,2	13,2	356	1,83
2	x	10RM	0,7	1,2	13,8	375	1,83
2	x	16RE	0,7	1,3	15,2	510	1,15
2	x	16RM	0,7	1,3	16,0	541	1,15
3	x	1,5RE	0,7	1,2	9,3	135	12,1
3	x	1,5RM	0,7	1,2	9,8	144	12,1
3	x	2,5RE	0,7	1,2	10,2	175	7,41
3	x	2,5RM	0,7	1,2	10,7	186	7,41
3	x	4RE	0,7	1,2	11,2	231	4,61
3	x	4RM	0,7	1,2	11,8	248	4,61
3	x	6RE	0,7	1,2	12,2	302	3,08
3	x	6RM	0,7	1,2	12,6	313	3,08
3	x	10RE	0,7	1,2	13,9	441	1,83

Number and cross-sectional area of conductor			Nominal thickness of insulation	Nominal thickness of sheath	Approximate overall diameter	Approximate net weight of cables	Maximum conductor resistance at 20°C
n x mm ²			mm	mm	mm	kg/km	W/km
3	x	10RM	0,7	1,2	14,6	462	1,83
3	x	16RE	0,7	1,3	16,1	643	1,15
3	x	16RM	0,7	1,3	17,0	677	1,15
3	x	25RM	0,9	1,3	21,2	1070	0,727
3	x	35RM	0,9	1,4	23,7	1412	0,524
3	x	35SM	0,9	1,4	21,4	1250	0,524
3	x	50SM	1,0	1,5	23,9	1647	0,387
3	x	70SM	1,1	1,5	27,9	2324	0,268
3	x	95SM	1,1	1,6	31,0	3114	0,193
3	x	120SM	1,2	1,7	34,1	3874	0,153
3	x	150SM	1,4	1,7	38,0	4782	0,124
3	x	185SM	1,6	1,8	42,0	5926	0,0991
3	x	240SM	1,7	1,9	47,1	7706	0,0754
3	x	25RM/16RE	0,9 / 0,7	1,4	22,2	1231	0,727 / 1,15
3	x	35SM/16RE	0,9 / 0,7	1,4	24,0	1438	0,524 / 1,15
3	x	50SM/25RM	1,0 / 0,9	1,5	27,0	1937	0,387 / 0,727
3	x	70SM/35SM	1,1 / 0,9	1,5	30,2	2693	0,268 / 0,524
3	x	95SM/50SM	1,1 / 1,0	1,6	33,8	3616	0,193 / 0,387
3	x	120SM/70SM	1,2 / 1,4	1,7	37,0	4569	0,153 / 0,268
3	x	150SM/70SM	1,4 / 1,4	1,8	41,6	5510	0,124 / 0,268
3	x	185SM/95SM	1,6 / 1,1	1,9	45,6	6897	0,0991 / 0,193
3	x	240SM/120SM	1,7 / 1,2	2,0	51,4	8931	0,0754 / 0,153
4	x	1,5RE	0,7	1,2	10,1	158	12,1
4	x	1,5RM	0,7	1,2	10,5	167	12,1
4	x	2,5RE	0,7	1,2	11,0	207	7,41
4	x	2,5RM	0,7	1,2	11,6	221	7,41
4	x	4RE	0,7	1,2	12,1	279	4,61
4	x	4RM	0,7	1,2	12,8	297	4,61
4	x	6RE	0,7	1,2	13,3	368	3,08
4	x	6RM	0,7	1,2	13,7	381	3,08
4	x	10RE	0,7	1,3	15,4	553	1,83
4	x	10RM	0,7	1,3	16,1	576	1,83
4	x	16RE	0,7	1,3	17,6	801	1,15
4	x	16RM	0,7	1,3	18,6	839	1,15
4	x	25RM	0,9	1,4	23,5	1340	0,727
4	x	35RM	0,9	1,4	26,0	1770	0,524
4	x	35SM	0,9	1,4	24,0	1619	0,524
4	x	50SM	1,0	1,5	27,0	2144	0,387
4	x	70SM	1,1	1,6	31,6	3038	0,268
4	x	95SM	1,1	1,7	35,2	4083	0,193
4	x	120SM	1,2	1,7	39,1	5092	0,153
4	x	150SM	1,4	1,8	43,2	6264	0,124
4	x	185SM	1,6	1,9	47,6	7763	0,0991
4	x	240SM	1,7	2,0	53,5	10106	0,0754

Number and cross-sectional area of conductor			Nominal thickness of insulation	Nominal thickness of sheath	Approximate overall diameter	Approximate net weight of cables	Maximum conductor resistance at 20°C
n x mm ²			mm	mm	mm	kg/km	W/km
5	x	1,5RE	0,7	1,2	10,9	186	12,1
5	x	1,5RM	0,7	1,2	11,4	197	12,1
5	x	2,5RE	0,7	1,2	11,9	246	7,41
5	x	2,5RM	0,7	1,2	12,6	263	7,41
5	x	4RE	0,7	1,2	13,1	333	4,61
5	x	4RM	0,7	1,2	14,0	356	4,61
5	x	6RE	0,7	1,2	14,4	443	3,08
5	x	6RM	0,7	1,2	14,9	458	3,08
5	x	10RE	0,7	1,3	16,8	670	1,83
5	x	10RM	0,7	1,3	17,6	697	1,83
5	x	16RE	0,7	1,3	19,2	975	1,15
5	x	16RM	0,7	1,3	20,3	1021	1,15
7	x	1,5RE	0,7	1,2	11,7	226	12,1
7	x	1,5RM	0,7	1,2	12,3	239	12,1
7	x	2,5RE	0,7	1,2	12,8	304	7,41
7	x	2,5RM	0,7	1,2	13,6	324	7,41
7	x	4RE	0,7	1,2	14,2	420	4,61
9	x	1,5RE	0,7	1,2	13,6	290	12,1
9	x	1,5RM	0,7	1,2	14,4	308	12,1
10	x	1,5RE	0,7	1,2	14,4	314	12,1
10	x	1,5RM	0,7	1,2	15,2	334	12,1
10	x	2,5RE	0,7	1,3	16,2	436	7,41
10	x	2,5RM	0,7	1,3	17,2	464	7,41
10	x	4RE	0,7	1,3	18,0	603	4,61
12	x	1,5RE	0,7	1,2	14,9	350	12,1
12	x	1,5RM	0,7	1,2	15,7	371	12,1
12	x	2,5RE	0,7	1,3	16,6	488	7,41
12	x	2,5RM	0,7	1,3	17,7	519	7,41
12	x	4RE	0,7	1,3	18,6	682	4,61
14	x	1,5RE	0,7	1,3	15,8	398	12,1
14	x	1,5RM	0,7	1,3	16,7	421	12,1
14	x	2,5RE	0,7	1,3	17,5	549	7,41
14	x	2,5RM	0,7	1,3	18,6	582	7,41
14	x	4RE	0,7	1,3	19,5	771	4,61
15	x	2,5RE	0,7	1,3	18,4	598	7,41
16	x	1,5RE	0,7	1,3	16,6	443	12,1
16	x	1,5RM	0,7	1,3	17,5	469	12,1
16	x	2,5RE	0,7	1,4	18,4	615	7,41
17	x	4RE	0,7	1,4	21,8	945	4,61

Number and cross-sectional area of conductor			Nominal thickness of insulation	Nominal thickness of sheath	Approximate overall diameter	Approximate net weight of cables	Maximum conductor resistance at 20°C
n x mm ²			mm	mm	mm	kg/km	W/km
19	x	1,5RE	0,7	1,3	17,4	501	12,1
19	x	1,5RM	0,7	1,3	18,4	529	12,1
19	x	2,5RE	0,7	1,3	19,3	700	7,41
19	x	2,5RM	0,7	1,3	20,6	741	7,41
19	x	4RE	0,7	1,4	21,8	1003	4,61
20	x	2,5RE	0,7	1,4	20,4	754	7,41
24	x	1,5RE	0,7	1,4	20,4	635	12,1
24	x	1,5RM	0,7	1,4	21,6	672	12,1
24	x	2,5RE	0,7	1,4	22,6	887	7,41
24	x	2,5RM	0,7	1,4	24,1	940	7,41
30	x	1,5RE	0,7	1,4	21,5	747	12,1
30	x	2,5RE	0,7	1,4	23,9	1055	7,41
37	x	1,5RE	0,7	1,4	23,1	886	12,1
40	x	1,5RE	0,7	1,4	23,9	947	12,1
40	x	2,5RE	0,7	1,5	26,9	1362	7,41

FLAMEBLOCKER (N)2XH FE180 0,6/1 kV

Based on VDE 0276-604 and IEC 60502-1

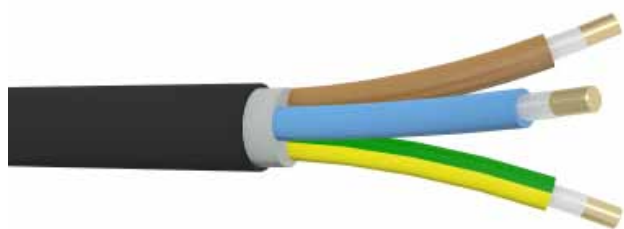

Halogen-free low
smoke fire resistant
security power cables

FIRE PERFORMANCE

Flame retardant:	IEC 60332-3-24 Category C
Smoke density:	IEC 61034-2: light transmittance values > 70%
Gases evolved during combustion:	IEC 60754-2: pH ≥ 4,3; conductivity ≤ 100 μS/cm
Insulation integrity under flame propagation:	IEC 60331-21

CONSTRUCTION

Conductors:	bare annealed copper conductor, solid circular class 1 or stranded circular or shaped class 2 acc. to EN 60228
Primary insulation:	a suitable wrapping of mica tape with a glass cloth
Insulation:	cross-linked polyethylene
Inner covering:	special flame-retardant and halogen-free compound
Sheath:	thermoplastic halogen - free compound type ST ₈ acc. to IEC 60502-1

CHARACTERISTIC

Colour of sheath:	Black (available also in Orange RAL 2003)
Core identification:	HD 308 S2

	without protective conductor-0	with protective conductor-J
1-core	black	green-yellow
2-core	blue, brown	-
3-core:	brown, black, grey	green-yellow, blue, brown
4-core:	blue, brown, black, grey	green-yellow, brown, black, grey
5-core:	blue, brown, black, grey, black	green-yellow, blue, brown, black, grey
7 and more:	numbering	green-yellow, other cores with numbering

Maximum conductor operating temperature:	+90°C
Lowest ambient temperature for fixed installation:	-40°C
Lowest installation temperature:	-5°C
Maximum short-circuit conductor temperature:	+250°C
Minimum bending radius:	12 x D (D is the overall diameter of the cable)
Maximum permissible tensile stress with cable grip for Cu-conductor:	50 N/mm ²

Application: Fire resistant security cables for installation everywhere where high safety requirements have a special significance e.g., in industrial complexes, power stations, public buildings, hotels, underground railway systems, hospitals etc.

Standard length cable packing: 500 or 1000m on drums. Other forms of packing and delivery are available on request.

Number and cross-sectional area of conductor	Nominal thickness of insulation	Nominal thickness of sheath	Approximate overall diameter	Approximate net weight of cable	Maximum conductor resistance at 20oC
n x mm ²	mm	mm	mm	kg/km	W/km
1x1,5RE	0,7	1,8	7,3	70	12,1
1x2,5RE	0,7	1,8	7,7	82	7,41
1x4RE	0,7	1,8	8,2	101	4,61
2x1,5RE	0,7	1,8	13,0	231	12,1
2x2,5RE	0,7	1,8	13,8	271	7,41
2x4RE	0,7	1,8	14,7	324	4,61
2x6RE	0,7	1,8	15,7	388	3,08
3x1,5RE	0,7	1,8	13,6	253	12,1
3x2,5RE	0,7	1,8	14,4	300	7,41
3x4RE	0,7	1,8	15,4	366	4,61
3x6RE	0,7	1,8	16,5	448	3,08
3x10RE	0,7	1,8	18,2	603	1,83
3x16RE	0,7	1,8	20,1	815	1,15
4x1,5RE	0,7	1,8	14,6	289	12,1
4x2,5RE	0,7	1,8	15,5	346	7,41
4x4RE	0,7	1,8	16,6	428	4,61
4x10RE	0,7	1,8	19,7	724	1,83
4x16RE	0,7	1,8	21,9	992	1,15
5x1,5RE	0,7	1,8	15,6	331	12,1
5x2,5RE	0,7	1,8	16,7	402	7,41
5x4RE	0,7	1,8	17,9	501	4,61
5x6RE	0,7	1,8	19,2	624	3,08
5x10RE	0,7	1,8	21,4	864	1,83
5x16RE	0,7	1,8	23,8	1192	1,15
10x1,5RE	0,7	1,8	20,6	477	12,1

FLAMEBLOCKER N2XCH 0,6/1 kV

DIN VDE 0276-604, DIN VDE 0276-627



Halogen-free low
smoke power cables
with copper
concentric conductor

FIRE PERFORMANCE

Flame propagation:	DIN EN 50266-2-4, VDE 0482-266-2-4, IEC 60332-3-24
Smoke density:	DIN EN 61034-2, VDE 0482-1034-2, IEC 61034-2
Gases evolved during combustion:	DIN EN 50267-2-2, VDE 0482-267-2-2, IEC 60754-2: pH \geq 4,3; conductivity \leq 2,5 μ S/mm

CONSTRUCTION

Conductors:	bare annealed copper conductor, circular solid class 1 (RE) or circular or circular compacted stranded class 2 (RM) or stranded sector - shaped conductor class 2 (SM) according to EN 60228
Insulation:	cross-linked polyethylene XLPE type 2X11 according to DIN VDE 0276-604
Inner covering:	special flame-retardant and halogen-free compound
Concentric conductor:	inner layer - round copper wires, outer layer - copper tape
Separator:	tape
Sheath:	thermoplastic halogen - free compound type HM4 according to DIN VDE 0276-604

CHARACTERISTIC

Colour of sheath:	black
Core identification:	according to HD 308 S2 or EN 50334
2-core:	blue, brown
3-core:	brown, black, grey
3 core:*	blue, brown, black
4-core:	blue, brown, black, grey
\geq 7-core:	black with numbering
*For certain applications only.	
Maximum conductor operating temperature:	+90°C
Lowest ambient temperature for fixed installation:	-30°C
Lowest installation temperature:	-5°C
Maximum short-circuit conductor temperature:	+250°C
Minimum bending radius:	15D - for single core cable; 12D - for multicore cable (D - overall cable diameter)
Maximum permissible tensile stress with cable grip for Cu-conductor:	50 N/mm ²
Application:	for the supply of electrical energy, especially for installations where fire and emissions of smoke and toxic fumes create a potential threat. The concentric conductor with a traverse spiral of copper serves as a screen and can be used as PE or PEN conductor. Not suitable for use in water.
Standard packing:	500 m on drums. Other forms of packing and delivery are available on request.

Number and cross-sectional area of conductor			Nominal thickness of insulation	Nominal thickness of sheath	Approximate overall diameter	Approximate net weight of cables	Maximum conductor resistance at 20°C
n x mm ²			mm	mm	mm	kg/km	W/km
2	x	1,5RE/1,5	0,7	1,2	10,7	174	12,1 / 12,1
2	x	2,5RE/2,5	0,7	1,2	11,5	215	7,41 / 7,41
2	x	4RE/4	0,7	1,2	12,8	282	4,61 / 4,61
2	x	6RE/6	0,7	1,2	14,1	359	3,08 / 3,08
2	x	10RE/10	0,7	1,2	15,8	507	1,83 / 1,83
2	x	16RE/16	0,7	1,3	18,3	729	1,15 / 1,15
2	x	25RM/16	0,9	1,3	23,0	1061	0,727 / 1,15
3	x	1,5RE/1,5	0,7	1,2	11,1	191	12,1 / 12,1
3	x	2,5RE/2,5	0,7	1,2	12,0	242	7,41 / 7,41
3	x	4RE/4	0,7	1,2	13,4	322	4,61 / 4,61
3	x	6RE/6	0,7	1,2	14,7	414	3,08 / 3,08
3	x	10RE/10	0,7	1,3	16,5	595	1,83 / 1,83
3	x	16RE/16	0,7	1,3	19,2	866	1,15 / 1,15
3	x	16RM/16	0,7	1,3	20,1	902	1,15 / 1,15
3	x	25RM/16	0,9	1,4	24,4	1289	0,727 / 1,15
3	x	35RM/16	0,9	1,4	26,7	1625	0,524 / 1,15
3	x	50 SM /25	1,0	1,5	29,5	1946	0,367/ 0,727
3	x	70 SM /35	1,1	1,6	34,7	2742	0,268 / 0,524
3	x	95 SM /50	1,1	1,6	38,1	3636	0,193 / 0,387
3	x	120 SM /70	1,2	1,7	42,5	4606	0,153 / 0,268
3	x	150 SM /70	1,4	1,8	47,0	5552	0,124 / 0,268
3	x	185 SM /95	1,6	1,9	51,4	6937	0,0991 / 0,193
3	x	240 SM /120	1,7	2,0	57,1	8964	0,0754 / 0,153
4	x	1,5RE/1,5	0,7	1,2	11,9	225	12,1 / 12,1
4	x	2,5RE/2,5	0,7	1,2	12,8	277	7,41 / 7,41
4	x	4RE/4	0,7	1,2	14,3	372	4,61 / 4,61
4	x	6RE/6	0,7	1,2	15,8	484	3,08 / 3,08
4	x	10RE/10	0,7	1,3	18,0	712	1,83 / 1,83
4	x	16RE/16	0,7	1,3	20,7	1029	1,15 / 1,15
4	x	16RM/16	0,7	1,3	21,7	1071	1,15 / 1,15
4	x	25RM/16	0,9	1,4	26,5	1552	0,727 / 1,15
4	x	35RM/16	0,9	1,5	29,0	1987	0,524 / 1,15
4	x	35 SM /16	0,9	1,5	26,7	1789	0,524 / 1,15
4	x	50 SM /25	1,0	1,5	29,5	2393	0,367/ 0,727
4	x	70 SM /35	1,1	1,6	34,7	3382	0,268 / 0,524
4	x	95 SM /50	1,1	1,7	38,3	4533	0,193 / 0,387
4	x	120 SM /70	1,2	1,8	43,1	5770	0,153 / 0,268
4	x	150 SM /70	1,4	1,9	47,2	6943	0,124 / 0,268
4	x	185 SM /95	1,6	2,0	51,6	8674	0,0991 / 0,193
4	x	240 SM /120	1,7	2,1	57,3	11232	0,0754 / 0,153
5	x	1,5RE/1,5	0,7	1,2	12,6	256	12,1/12,1
5	x	2,5RE/2,5	0,7	1,2	13,6	320	7,41/7,41
5	x	4RE/4	0,7	1,2	15,2	431	4,61/4,61
5	x	6RE/6	0,7	1,3	17	572	3,08/3,08
5	x	10RE/10	0,7	1,3	19,3	836	1,83/1,83

Number and cross-sectional area of conductor		Nominal thickness of insulation	Nominal thickness of sheath	Approximate overall diameter	Approximate net weight of cables	Maximum conductor resistance at 20°C	
n x mm ²		mm	mm	mm	kg/km	W/km	
5	x	16RE/16	0,7	1,4	22,4	1221	1,15/1,15
5	x	25RMC/16	0,9	1,4	28,5	1792	0,727/1,15
5	x	35RMC/16	0,9	1,5	31,6	2322	0,524/1,15
5	x	50RMC/25	1	1,6	36,1	3151	0,387/0,727
5	x	70SM 72°/35	1,1	1,7	36,7	4054	0,268/0,524
5	x	95SM 72°/50	1,1	1,8	41,6	5505	0,193/0,387
5	x	120SM 72°/70	1,2	1,9	46	6945	0,153/0,268
5	x	150SM 72°/70	1,4	2	50,9	8399	0,124/0,268
5	x	185SM 72°/95	1,6	2,1	55,8	10528	0,0991/0,193
5	x	240SM 72°/120	1,7	2,2	61,5	13566	0,0754/0,153
7	x	1,5RE/2,5	0,7	1,2	13,5	298	12,1 / 7,41
7	x	2,5RE/2,5	0,7	1,2	14,6	381	7,41 / 7,41
7	x	4RE/4	0,7	1,3	16,4	521	4,61 / 4,61
10	x	1,5RE/2,5	0,7	1,3	16,4	404	12,1 / 7,41
10	x	2,5RE/4	0,7	1,3	18,4	545	7,41 / 4,61
10	x	4RE/6	0,7	1,3	20,5	736	4,61 / 3,08
12	x	1,5RE/2,5	0,7	1,3	16,9	442	12,1 / 7,41
12	x	2,5RE/4	0,7	1,3	18,8	598	7,41 / 4,61
12	x	4RE/6	0,7	1,3	21,1	818	4,61 / 3,08
14	x	1,5RE/2,5	0,7	1,3	17,6	486	12,1 / 7,41
14	x	2,5RE/4	0,7	1,3	19,7	662	7,41 / 4,61
14	x	4RE/6	0,7	1,4	22,2	920	4,61 / 3,08
15	x	1,5RE/2,5	0,7	1,3	18,4	523	12,1 / 7,41
16	x	1,5RE/4	0,7	1,3	18,8	553	12,1 / 4,61
16	x	2,5RE/6	0,7	1,3	20,9	749	7,41 / 3,08
19	x	1,5RE/4	0,7	1,3	19,6	614	12,1 / 4,61
19	x	2,5RE/6	0,7	1,4	21,8	838	7,41 / 3,08
19	x	4RE/10	0,7	1,4	24,4	1187	4,61 / 1,83
24	x	1,5RE/6	0,7	1,4	22,6	775	12,1 / 3,08
24	x	2,5RE/10	0,7	1,4	25,2	1073	7,41 / 1,83
30	x	1,5RE/6	0,7	1,4	23,7	891	12,1 / 3,08
30	x	2,5RE/10	0,7	1,5	26,5	1245	7,41 / 1,83
40	x	1,5RE/10	0,7	1,5	26,5	1137	12,1 / 1,83
40	x	2,5RE/10	0,7	1,5	29,5	1564	7,41 / 1,83

FLAMEBLOCKER (N)2XCH FE180 0,6/1 kV

Based on VDE 0276-604 and IEC 60502-1

Halogen-free low
smoke fire resistant
security power cables



FIRE PERFORMANCE

Flame retardant:	IEC 60332-3-24 Category C
Smoke density:	IEC 61034-2: light transmittance values > 70%
Gases evolved during combustion:	IEC 60754-2: pH \geq 4,3; conductivity \leq 100 μ S/mm
Insulation integrity under flame propagation:	IEC 60331-21

CONSTRUCTION

Conductors:	bare annealed copper conductor, solid circular class 1 or stranded circular or shaped class 2 acc. to EN 60228
Primary insulation:	a suitable wrapping of mica tape with a glass cloth
Insulation:	cross-linked polyethylene
Inner covering:	special flame-retardant and halogen-free compound
Sheath:	thermoplastic halogen - free compound type ST8 acc. to IEC 60502-1

CHARACTERISTIC

Colour of sheath:	Black (Orange available on request)
Core identification:	HD 308 S2
2-core	blue, brown
4-core:	blue, brown, black, grey
7 and more:	numbering
Maximum conductor operating temperature:	+90°C
Lowest ambient temperature for fixed installation:	-40°C
Lowest installation temperature:	-5°C
Maximum short-circuit conductor temperature:	+250°C
Minimum bending radius:	12 x D (D is the overall diameter of the cable)
Application:	Fire resistant security cables for installation everywhere where high safety requirements have a special significance e.g., in industrial complexes, power stations, public buildings, hotels, underground railway systems, hospitals etc.
Standard packing:	500 or 1000m on drums. Other forms of packing and delivery are available on request.

Number and cross-sectional area of conductor			Nominal thickness of insulation	Nominal thickness of sheath	Approximate overall diameter	Approximate net weight of cables	Maximum conductor resistance at 20°C
n x mm ²			mm	mm	mm	kg/km	W/km
2	x	1,5RE/1,5	0,7	1,8	14,2	266	12,1/12,1
2	x	2,5RE/2,5	0,7	1,8	15,0	305	7,41/7,41
2	x	4RE/4	0,7	1,8	16,3	379	4,61/4,61
2	x	6RE/6	0,7	1,8	17,6	463	3,08/3,08
3	x	1,5RE/1,5	0,7	1,8	14,8	288	12,1/12,1
3	x	2,5RE/2,5	0,7	1,8	15,6	335	7,41/7,41
3	x	4RE/4	0,7	1,8	17,0	422	4,61/4,61
3	x	6RE/6	0,7	1,8	18,4	523	3,08/3,08
3	x	10RE/10	0,7	1,8	20,2	715	1,83/1,83
3	x	16RE/16	0,7	1,8	24,2	1003	1,15/1,15
4	x	1,5RE/1,5	0,7	1,8	15,8	323	12,1/12,1
4	x	2,5RE/2,5	0,7	1,8	16,7	381	7,41/7,41
4	x	4RE/4	0,7	1,8	18,2	484	4,61/4,61
4	x	10RE/10	0,7	1,8	21,7	837	1,83/1,83
4	x	16RE/16	0,7	1,8	24,4	1167	1,15/1,15
5	x	1,5RE/1,5	0,7	1,8	16,8	365	12,1/12,1
5	x	2,5RE/2,5	0,7	1,8	17,9	437	7,41/7,41
5	x	4RE/4	0,7	1,8	19,5	558	4,61/4,61
5	x	6RE/6	0,7	1,8	21,1	700	3,08/3,08
5	x	10RE/10	0,7	1,8	25,0	992	1,83/1,83
5	x	16RE/16	0,7	1,8	26,3	1369	1,15/1,15
10	x	1,5RE/2,5	0,7	1,8	21,7	572	12,1/7,41

Halogen-free light sheathed cables with improved fire behaviour

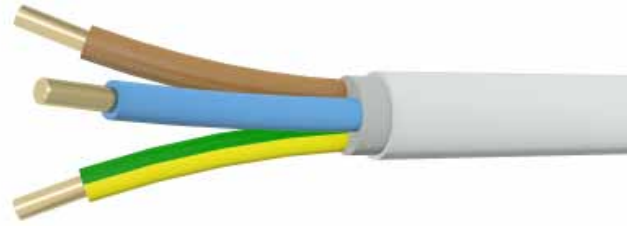

FIRE PERFORMANCE

Flame propagation:	DIN EN 50266-2-4, DIN VDE 0482-266-2-4, IEC 60332-3-24
Smoke density:	DIN EN 61034-2, DIN VDE 0482-1034-2, IEC 61034-2
Gases evolved during combustion:	DIN EN 50267-2-2, DIN VDE 0482-267-2-2, IEC 60754-2: pH ≥ 4,3; conductivity ≤ 2,5 μS/mm

CONSTRUCTION

Conductors:	solid or stranded plain copper according to DIN EN 60228
Insulation:	cross-linked polyethylene XLPE type 2X11 according to DIN VDE 0276-604
Filling:	halogen-free not vulcanized rubber compound
Sheath:	special halogen-free thermoplastic compound type HM2 according to DIN VDE 0250-214

CHARACTERISTIC

Core identification:

	with protective conductor NHXMH-J	without protective conductor NHXMH-0
single-core	green/yellow	black
twin	---	blue, brown
3-core	green/yellow, brown, grey	brown, black, grey
4-core	green/yellow, brown, black, grey	blue, brown, black, grey
5-core	green/yellow, blue, brown, black, grey	blue, brown, black, grey, black
7-core	other cores black with white numbering	black with white numbering

Maximum conductor operating temperature: +70°C

Lowest ambient temperature for fixed installation: -30°C

Lowest installation temperature: -5°C

Maximum short-circuit conductor temperature: +250°C

Minimum bending radius: for single core cables: 10D, for multi-core cables: 6D; (D – overall cable diameter)

Application: Installation cables for industrial complexes, public buildings, hotels, airports, hospitals or industrial plants with high concentration of people and/or property. Usable in the open, in dry, damp and wet environments in the open and concealed, as well as in masonry and in concrete, not suitable for imbedding in solidified – or compressed – concrete.

Standard packing: 100 m coils or 500 m on drums. Other forms of packing and delivery are available on request.

Number and cross-sectional area of conductor			Nominal thickness of insulation	Nominal thickness of sheath	Approximate overall diameter	Approximate net weight	Maximum conductor resistance at 20°C	Caloric load
n x mm ²			mm	mm	mm	kg/km	W/km	kWh/m
1	x	1,5	0,5	1,4	5,1	40	12,1	0,33
1	x	2,5	0,5	1,4	5,4	51	7,41	0,36
1	x	4	0,6	1,4	6,0	68	4,61	0,42
1	x	6	0,6	1,4	6,5	88	3,08	0,44
1	x	10	0,7	1,4	7,5	132	1,83	0,53
1	x	16	0,7	1,4	8,6	191	1,15	0,64
2	x	1,5	0,5	1,4	7,7	94	12,1	0,36
2	x	2,5	0,5	1,4	8,5	123	7,41	0,42
2	x	4	0,6	1,4	9,8	173	4,61	0,56
2	x	6	0,6	1,4	10,8	226	3,08	0,64
2	x	10	0,7	1,6	13,3	357	1,83	0,97
2	x	16	0,7	1,6	16,0	539	1,15	1,3
2	x	25	0,9	1,6	19,4	814	0,727	1,8
2	x	35	0,9	1,8	22,1	1093	0,524	2,3
3	x	1,5	0,5	1,4	8,1	109	12,1	0,42
3	x	2,5	0,5	1,4	8,9	146	7,41	0,47
3	x	4	0,6	1,4	10,3	209	4,61	0,61
3	x	6	0,6	1,6	11,8	289	3,08	0,78
3	x	10	0,7	1,6	14,0	443	1,83	1,1
3	x	16	0,7	1,6	17,0	674	1,15	1,5
3	x	25	0,9	1,8	21,0	1045	0,727	2,1
3	x	35	0,9	1,8	23,7	1399	0,524	2,5
4	x	1,5	0,5	1,4	8,7	129	12,1	0,47
4	x	2,5	0,5	1,4	9,6	176	7,41	0,56
4	x	4	0,6	1,6	11,6	265	4,61	0,78
4	x	6	0,6	1,6	12,8	353	3,08	0,94
4	x	10	0,7	1,6	15,3	547	1,83	1,3
4	x	16	0,7	1,6	18,6	837	1,15	1,8
4	x	25	0,9	1,8	23,3	1312	0,727	2,6
4	x	35	0,9	1,8	26,0	1754	0,524	3,1
5	x	1,5	0,5	1,4	9,4	153	12,1	0,56
5	x	2,5	0,5	1,4	10,4	209	7,41	0,64
5	x	4	0,6	1,6	12,6	317	4,61	0,98
5	x	6	0,6	1,6	13,9	426	3,08	1,1
5	x	10	0,7	1,6	16,8	668	1,83	1,5
5	x	16	0,7	1,8	20,7	1039	1,15	2,2
5	x	25	0,9	1,8	25,5	1600	0,727	3,1
5	x	35	0,9	1,8	28,6	2132	0,524	3,7
7	x	1,5	0,5	1,4	10,1	188	12,1	0,64
7	x	2,5	0,5	1,6	11,6	274	7,41	0,81

FLAMEBLOCKER (N)HXMH(St) 300/500V

Based on DIN VDE 0250-214, DIN VDE 0250-209/2

Halogen-free
sheathed screened
cables with improved
fire behaviour

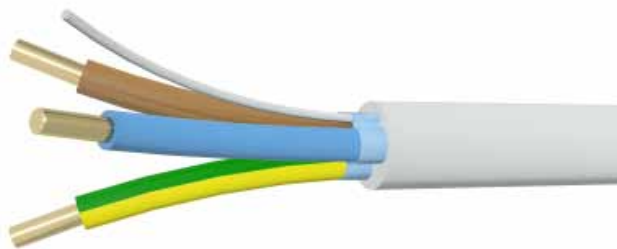

FIRE PERFORMANCE

Flame propagation:	DIN EN 50266-2-4, DIN VDE 0482-266-2-4, IEC 60332-3-24
Smoke density:	DIN EN 61034-2, DIN VDE 0482-1034-2, IEC 61034-2
Gases evolved during combustion:	DIN EN 50267-2-2, DIN VDE 0482-267-2-2, IEC 60754-2: pH \geq 4,3; conductivity \leq 2,5 μ S/mm

CONSTRUCTION

Conductors:	solid or stranded plain copper according to DIN EN 60228
Insulation:	cross-linked polyethylene XLPE type 2X11 according to DIN VDE 0276-604
Screen:	coated aluminium foil
Drain wire:	solid tinned copper wire
Sheath:	special halogen-free thermoplastic compound type HM2 according to DIN VDE 0250-214

CHARACTERISTIC

Core identification:	according to DIN VDE 0293-308 (HD 308 S2)
-----------------------------	---

twin	blue, brown
3-core	green/yellow, blue, brown
4-core	green/yellow, brown, black, grey
5-core	green/yellow, blue, brown, black, grey
7-core	green/yellow, other cores black with white numbering

Maximum conductor operating temperature:	+70°C
---	-------

Lowest ambient temperature for fixed installation:	-30°C
---	-------

Lowest installation temperature:	-5°C
---	------

Maximum short-circuit conductor temperature:	+250°C
---	--------

Minimum bending radius:	10D (D – overall cable diameter)
--------------------------------	----------------------------------

Application:	Installation cables for industrial complexes, public buildings, hotels, airports, hospitals or industrial plants with high concentration of people or property. Usable in the open, in dry, damp and wet environments in the open and concealed, as well as in masonry and in concrete.
---------------------	---

Standard packing:	100 m in coils or 500 m on drums. Other forms of packing and delivery are available on request.
--------------------------	---

Number and cross-sectional area of conductor			Nominal thickness of insulation	Nominal thickness of sheath	Approximate overall diameter	Approximate net weight	Maximum conductor resistance at 20°C
n x mm ²			mm	mm	mm	kg/km	W/km
2	x	1,5/1,5	0,6	1,4	8,0	107	12,1 / 12,1
2	x	2,5/1,5	0,6	1,4	8,8	135	7,41 / 12,1
2	x	4 /1,5	0,6	1,4	9,7	175	4,61 / 12,1
2	x	6 /1,5	0,6	1,4	10,7	225	3,08 / 12,1
3	x	1,5/1,5	0,6	1,4	8,5	124	12,1 / 12,1
3	x	2,5/1,5	0,6	1,4	9,2	159	7,41 / 12,1
3	x	4 /1,5	0,6	1,4	10,2	212	4,61 / 12,1
3	x	6 /1,5	0,6	1,6	11,7	289	3,08 / 12,1
4	x	1,5/1,5	0,6	1,4	9,4	146	12,1 / 12,1
4	x	2,5/1,5	0,6	1,4	10,1	191	7,41 / 12,1
4	x	4 /1,5	0,6	1,4	11,1	258	4,61 / 12,1
4	x	6 /1,5	0,6	1,6	12,7	355	3,08 / 12,1
5	x	1,5/1,5	0,6	1,4	10,2	170	12,1 / 12,1
5	x	2,5/1,5	0,6	1,4	11,1	226	7,41 / 12,1
5	x	4 /1,5	0,6	1,6	12,5	319	4,61 / 12,1
5	x	6 /1,5	0,6	1,6	13,8	425	3,08 / 12,1
7	x	1,5/1,5	0,6	1,4	11,0	204	12,1 / 12,1
7	x	2,5/1,5	0,6	1,6	12,4	293	7,41 / 12,1

Power
the future



FLAMEBLOCKER H07Z-U, H07Z-R, H07Z-K 450/750V

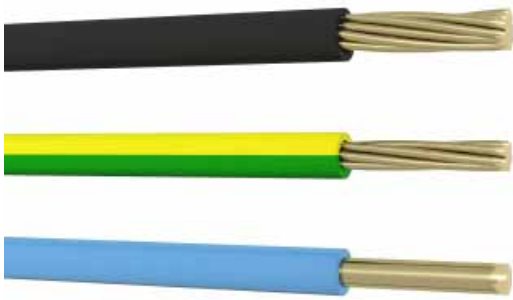

Single core
non-sheathed cables
with low emission of
smoke and corrosive
gases

FIRE PERFORMANCE

Flame propagation:	EN 60332-1-2 (IEC 60332-1)
Smoke emission:	EN 61034-2 (IEC 61034-2)
Corrosive and acid gas emission of insulation:	EN 50267-2-2 (IEC 60754-2): pH ≥ 4,3; Conductivity: ≤ 10 μS/mm

CONSTRUCTION

Conductor:	annealed copper, class 1 solid (H07Z-U), class 2 stranded (H07Z-R) or class 5 flexible (H07Z-K) according to EN 60228
Insulation:	special thermosetting, low smoke, zero halogen compound type EI5, according to EN 50363-5

CHARACTERISTIC

Colour of insulation:	green/yellow, black, blue, brown, grey, orange, pink, red, white or other colours.			
Minimum bending radius:	For cable diameter D (mm)			
	D ≤ 8	8 < D ≤ 12	12 < D ≤ 20	D > 20
Normal use	4 D	5 D	6 D	6 D
Careful bending at termination	2 D	3 D	4 D	4 D
Maximum conductor operating temperature:	+90°C			
Lowest ambient temperature for fixed installation (static):	-40°C			
Lowest installation temperature (flexing):	-5°C			
Maximum short-circuit temperature:	+250°C			
Test voltage 50Hz:	2500V			
Application:	when low emission of smoke and corrosive gases is required in case of burning. Intended for installation in surface mounted or embedded conduits, or similar closed systems. Suitable for fixed protected installation in, or on, lighting and control gear for voltages up to 1000 V AC or, up to 750V DC to earth.			
Standard packing:	100 m in coils or on spools, or 500 m on drums. Other forms of packing and delivery are available on request.			

H07Z-U 450/750V				
Nominal cross-sectional area of conductor	Radial thickness of insulation	Approximate overall diameter	Approximate net weight	Maximum resistance of conductor at temperature 20°C
mm ²	mm	mm	kg/km	W/km
1,5	0,7	2,8	20	12,1
2,5	0,8	3,3	30	7,41
4	0,8	3,8	45	4,61
6	0,8	4,3	63	3,08
10	1,0	5,5	105	1,83

H07Z-R 450/750V

Nominal cross-sectional area of conductor	Radial thickness of insulation	Approximate overall diameter	Approximate net weight	Maximum resistance of conductor at temperature 20°C
mm ²	mm	mm	kg/km	W/km
1,5	0,7	3,0	21	12,1
2,5	0,8	3,6	32	7,41
4	0,8	4,1	48	4,61
6	0,8	4,5	65	3,08
10	1,0	5,8	109	1,83
16	1,0	6,8	165	1,15
25	1,2	8,5	259	0,727
35	1,2	9,6	350	0,524
50	1,4	11,3	476	0,387
70	1,4	12,6	668	0,268
95	1,6	15,0	925	0,193
120	1,6	16,4	1151	0,153
150	1,8	18,4	1424	0,124
185	2,0	20,3	1778	0,0991
240	2,2	23,2	2312	0,0754
300	2,4	25,4	2892	0,0601
400	2,6	29,4	3747	0,0470
500*	2,8	32,1	4775	0,0366
630*	2,8	36,3	6039	0,0283

*In BS 7211

H07Z-K 450/750V

Nominal cross-sectional area of conductor	Radial thickness of insulation	Approximate overall diameter	Approximate net weight	Maximum resistance of conductor at temperature 20°C
mm ²	mm	mm	kg/km	W/km
1,5	0,7	2,9	19	13,3
2,5	0,8	3,6	30	7,98
4	0,8	4,1	44	4,95
6	0,8	4,6	62	3,30
10	1,0	6,0	105	1,91
16	1,0	7,1	159	1,21
25	1,2	8,7	245	0,780
35	1,2	9,8	340	0,554
50	1,4	11,8	479	0,386
70	1,4	13,6	664	0,272
95	1,6	16,1	879	0,206
120	1,6	17,2	1104	0,161
150	1,8	19,4	1380	0,129
185	2,0	22,1	1685	0,106
240	2,2	24,0	2196	0,0801
300*	2,4	28,0	2751	0,0641
400*	2,6	30,3	3587	0,0486

*Type 072-K

FLAMEBLOCKER H07ZZ-F 450/750V

DIN VDE 0282-13 BS 7919

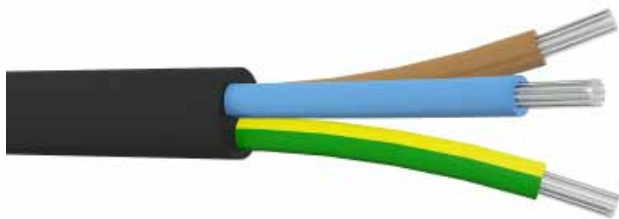

Single and multicore flexible cables, cross-linked halogen-free compound insulated and sheathed, with low smoke and corrosive gases emission

FIRE PERFORMANCE

Flame propagation:	EN-60332-1-2, EN 50266-2-4, IEC 60332-3-24
Smoke emission:	EN 61034-2, IEC 61034-2
Corrosive and acid gas emission of insulation:	EN 50267-2-2, IEC 60754-2: pH ≥ 4,3; Conductivity: ≤ 10 μS/mm

CONSTRUCTION

Conductors:	tinned annealed copper conductor flexible class 5 according to EN 60228
Insulation:	cross-linked halogen free compound type E18 according to EN 50363-5
Sheath:	cross-linked halogen free compound type EM8 according to EN 50363-6

CHARACTERISTIC

Colour of sheath:	Black			
Core identification:	according to HD 308 S2			
Single core twin:	green-yellow or black blue and brown			
3- core:	green-yellow, blue, brown			
4- core:	green-yellow, brown, black, grey			
5- core:	green-yellow, blue, brown, black, grey			
> 5 core:	green-yellow, other cores black with white numbering			
Maximum conductor operating temperature:	+70°C			
Lowest ambient temperature for fixed installation:	-5°C			
Maximum short-circuit conductor temperature:	+250°C			
Test voltage 50Hz:	2500V			
Pulling strength:	not exceed 15 N/mm ²			
Minimum bending radius:	For cable diameter D (mm)			
	D ≤ 8	8 < D ≤ 12	12 < D ≤ 20	D > 20
Normal use	4 D	5 D	6 D	6 D
Careful bending at termination	2 D	3 D	4 D	4 D
Application:	For indoor and temporary outdoors usage, particularly for situations in which low emission of smoke and corrosive gases is required in case of burning. Use up to 1000V AC is permitted for fixed, protected installation in appliances and also for motor connections of hoisting motors and the like.			
Standard packing:	500 m on drums. Other forms of packing and delivery are available on request.			

Number and cross-sectional area of conductor			Maximum diameter of wires	Nominal thickness of insulation	Nominal thickness of sheath	Approximate overall diameter	Approximate net weight	Maximum conductor resistance at temperature 20°C
n x mm ²			mm	mm	mm	mm	kg/km	W/km
1	x	16	0,41	1,2	1,9	11,4	247	1,24
1	x	25	0,41	1,4	2,0	13,2	353	0,795
1	x	35	0,41	1,4	2,2	14,4	462	0,565
1	x	50	0,41	1,6	2,4	17,1	648	0,393
1	x	70	0,51	1,6	2,6	19,3	870	0,277
1	x	95	0,51	1,8	2,8	22,2	1135	0,210
1	x	120	0,51	1,8	3,0	23,7	1395	0,164
1	x	150	0,51	2,0	3,2	26,3	1726	0,132
1	x	185	0,51	2,2	3,4	29,4	2098	0,108
1	x	240	0,51	2,4	3,5	31,5	2652	0,0817
1	x	300	0,51	2,6	3,6	35,7	3290	0,0654
1	x	400	0,51	2,8	3,8	38,4	4199	0,0495
1	x	500	0,61	3,0	4,0	43,8	5278	0,0391
2	x	1	0,21	0,8	1,3	8,2	89	20,0
2	x	1,5	0,26	0,8	1,5	9,2	114	13,7
2	x	2,5	0,26	0,9	1,7	11,0	166	8,21
2	x	4	0,31	1,0	1,8	12,5	226	5,09
2	x	6	0,31	1,0	2,0	14,1	297	3,39
2	x	10	0,41	1,2	3,1	19,1	535	1,95
2	x	16	0,41	1,2	3,3	21,8	732	1,24
2	x	25	0,41	1,4	3,6	25,6	1044	0,795
3	x	1	0,21	0,8	1,4	8,8	107	20,0
3	x	1,5	0,26	0,8	1,6	9,9	138	13,7
3	x	2,5	0,26	0,9	1,8	11,7	201	8,21
3	x	4	0,31	1,0	1,9	13,4	276	5,09
3	x	6	0,31	1,0	2,1	15,0	366	3,39
3	x	10	0,41	1,2	3,3	20,5	660	1,95
3	x	16	0,41	1,2	3,5	23,4	912	1,24
3	x	25	0,41	1,4	3,8	27,4	1308	0,795
3	x	35	0,41	1,4	4,1	29,5	1662	0,565
3	x	50	0,41	1,6	4,5	35,5	2363	0,393
3	x	70	0,51	1,6	4,8	40,0	3137	0,277
3	x	95	0,51	1,8	5,3	46,4	4144	0,210
3	x	120	0,51	1,8	5,6	49,3	5006	0,164
3	x	150	0,51	2,0	6,0	55,0	6214	0,132
3	x	185	0,51	2,2	6,4	61,4	7596	0,108
3	x	240	0,51	2,4	7,1	66,9	9617	0,0817

Number and cross-sectional area of conductor		Maximum diameter of wires	Nominal thickness of insulation	Nominal thickness of sheath	Approximate overall diameter	Approximate net weight	Maximum conductor resistance at temperature 20°C
n x mm ²		mm	mm	mm	mm	kg/km	W/km
4	x 1	0,21	0,8	1,5	9,7	131	20,0
4	x 1,5	0,26	0,8	1,7	10,9	169	13,7
4	x 2,5	0,26	0,9	1,9	12,9	247	8,21
4	x 4	0,31	1,0	2,0	14,7	340	5,09
4	x 6	0,31	1,0	2,3	16,7	459	3,39
4	x 10	0,41	1,2	3,4	22,4	805	1,95
4	x 16	0,41	1,2	3,6	25,6	1132	1,24
4	x 25	0,41	1,4	4,1	30,4	1659	0,795
4	x 35	0,41	1,4	4,4	32,7	2113	0,565
4	x 50	0,41	1,6	4,8	39,3	3001	0,393
4	x 70	0,51	1,6	5,2	44,5	4011	0,277
4	x 95	0,51	1,8	5,9	51,9	5333	0,210
4	x 120	0,51	1,8	6,0	54,7	6402	0,164
4	x 150	0,51	2,0	6,5	61,2	7969	0,132
4	x 185	0,51	2,2	7,0	68,5	9756	0,108
5	x 1	0,21	0,8	1,6	10,7	162	20,0
5	x 1,5	0,26	0,8	1,8	12,0	209	13,7
5	x 2,5	0,26	0,9	2,0	14,2	304	8,21
5	x 4	0,31	1,0	2,2	16,4	427	5,09
5	x 6	0,31	1,0	2,5	18,6	574	3,39
5	x 10	0,41	1,2	3,6	24,6	994	1,95
5	x 16	0,41	1,2	3,9	28,3	1398	1,24
5	x 25	0,41	1,4	4,4	33,6	2045	0,795
5	x 35*	0,41	1,4	4,6	36,0	2589	0,565
5	x 50*	0,41	1,6	5,2	43,6	3717	0,393
6	x 1,5	0,26	0,8	2,5	14,3	286	13,7
6	x 2,5	0,26	0,9	2,7	16,7	407	8,21
6	x 4	0,31	1,0	2,9	19,2	561	5,09
12	x 1,5	0,26	0,8	2,9	18,7	480	13,7
12	x 2,5	0,26	0,9	3,1	21,9	688	8,21
12	x 4	0,31	1,0	3,5	25,5	977	5,09
18	x 1,5	0,26	0,8	3,2	21,9	681	13,7
18	x 2,5	0,26	0,9	3,5	25,9	992	8,21
18	x 4	0,31	1,0	3,9	30,1	1407	5,09
24	x 1,5	0,26	0,8	3,5	25,6	884	13,7
24	x 2,5	0,26	0,9	3,9	30,5	1299	8,21
36	x 1,5	0,26	0,8	3,8	29,3	1233	13,7
36	x 2,5	0,26	0,9	4,3	35,1	1833	8,21

Halogen-free
thermoplastic
insulated
and sheathed flexible
cords

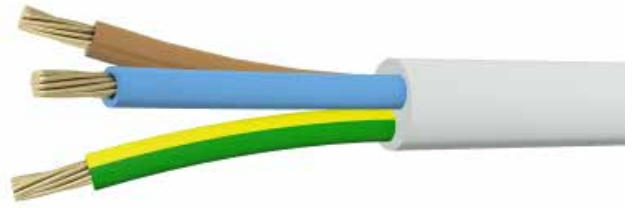

FIRE PERFORMANCE

Flame propagation:	EN 60332-1-2 (IEC 60332-1)
Smoke emission:	EN 61034-2 (IEC 61034-2)
Gases evolved during combustion:	EN 50267-2-1 (IEC 60754-1): < 0,5% acid gas EN 50267-2-2 (IEC 60754-2): pH ≥ 4,3; conductivity ≤ 10 μS/mm The product is conformed with the RoHS Directive 2002/95/CE, Low-Voltage Directive 2006/95/EC.

CONSTRUCTION

Conductors:	annealed copper conductor flexible class 5 acc. to EN 60228
Insulation:	thermoplastic halogen-free compound type Tl6 acc. to EN 50363-7
Sheath:	thermoplastic halogen-free compound type TM7 acc. to EN 50363-7

CHARACTERISTIC

Color of sheath:	white
Core identification:	HD 308 S2
twin core:	blue and brown
3-core:	green/yellow, blue, brown
4-core:	green/yellow, brown, black, grey
5-core:	green/yellow, blue, brown, black, grey
Test voltage 50Hz:	2000V
Maximum conductor operating temperature:	+ 60°C
Lowest installation temperature:	+5°C
Maximum short-circuit conductor temperature:	+150°C
Minimum bending radius:	7,5 x D, D – overall diameter of cable
Application:	These cables having low emission of smoke and corrosive gases when exposed to fire. These cables are intended for the connection of domestic appliances to the fixed supply, in domestic premises, kitchens, offices, for household appliances.
Standard length cable packing:	100 m in coils or 500 m on drums. Other forms of packing and delivery are available on request.

Number and nominal cross-sectional area of conductors	Maximum diameter of wires in conductor	Nominal thickness of insulation	Nominal thickness of sheath	Approximate overall diameter	Approximate net weight of cables	Maximum conductor resistance at temperature 20°C
n x mm ²	mm	mm	mm	mm	kg/km	W/km
2 x 0,75	0,21	0,6	0,8	6,2	58	26,0
2 x 1	0,21	0,6	0,8	6,4	64	19,5
2 x 1,5	0,26	0,7	0,8	7,4	87	13,3
2 x 2,5	0,26	0,8	1,0	9,2	136	7,98
2 x 4	0,31	0,8	1,1	10,3	182	4,95
3 x 0,75	0,21	0,6	0,8	6,6	68	26,0
3 x 1	0,21	0,6	0,8	6,7	76	19,5
3 x 1,5	0,26	0,7	0,9	8,0	109	13,3
3 x 2,5	0,26	0,8	1,1	9,9	168	7,98
3 x 4	0,31	0,8	1,2	11,1	228	4,95
4 x 0,75	0,21	0,6	0,8	6,2	58	26,0
4 x 1	0,21	0,6	0,8	6,4	64	19,5
4 x 1,5	0,26	0,7	0,8	7,4	87	13,3
4 x 2,5	0,26	0,8	1,0	9,2	136	7,98
4 x 4	0,31	0,8	1,1	10,3	182	4,95
5 x 0,75	0,21	0,6	0,8	6,6	68	26,0
5 x 1	0,21	0,6	0,8	6,7	76	19,5
5 x 1,5	0,26	0,7	0,9	8,0	109	13,3
5 x 2,5	0,26	0,8	1,1	9,9	168	7,98
5 x 4	0,31	0,8	1,2	11,1	228	4,95

Thermosetting
insulated, single-
core, sheathed cable
450/750V



FIRE PERFORMANCE

Flame propagation:	BS EN 60332-1-2
Smoke emission:	BS EN 61034-2
Corrosive and acid gas emission:	BS EN 50267-2-1; HCL < 0,5 %

CONSTRUCTION

Conductor:	annealed copper, solid class 1 or stranded conductor class 2 according to BS EN 60228
Insulation:	halogen-free thermosetting compound type E15 according to BS EN 50363-5
Colour of insulation:	brown and blue
Sheath:	halogen-free thermoplastic compound type LTS4 according to BS 7655-6.1
Colour of sheath:	white (other colours may be used)

CHARACTERISTIC

Maximum conductor operating temperature:	+90°C
Lowest installation temperature:	0°C
Maximum short-circuit conductor temperature:	+250°C
Test voltage 50Hz:	2500V
Minimum bending radius:	6D; (D- overall cable diameter)
Application:	for fixed installation in dry or damp areas for domestic and light industrial wiring. Particularly for situations in which low emission of smoke and corrosive gases is required in case of burning. These cables are not intended to provide circuit integrity in case of fire.
Standard packing:	100 m on spools or 500 m on drums. Other forms of packing and delivery are available on request.

Number and cross-sectional area of conductors		Class of conductor	Nominal thickness of insulation	Nominal thickness of sheath	Approximate overall diameter	Approximate net weight of cables	Maximum resistance of conductor at 20°C
n x mm ²			mm	mm	mm	kg/km	mm ²
1	x 1	1	0,7	0,8	4,1	27	18,1
1	x 1	2	0,7	0,8	4,3	28	18,1
1	x 1,5	1	0,7	0,8	4,4	33	12,1
1	x 1,5	2	0,7	0,8	4,6	35	12,1
1	x 2,5	1	0,7	0,8	4,7	44	7,41
1	x 2,5	2	0,7	0,8	5,0	47	7,41
1	x 4	1	0,7	0,8	5,2	60	4,61
1	x 4	2	0,7	0,9	5,7	66	4,61
1	x 6	1	0,7	0,9	5,9	82	3,08
1	x 6	2	0,7	0,9	6,1	85	3,08
1	x 10	2	0,7	0,9	7,0	127	1,83
1	x 16	2	0,7	0,9	8,0	186	1,15
1	x 25	2	0,9	1,0	9,9	290	0,727
1	x 35	2	0,9	1,1	11,2	389	0,524

Double insulated
surface wiring cable



FIRE PERFORMANCE

Flame propagation:	BS EN 60332-1-2
Smoke emission:	BS EN 61034-2
Corrosive and acid gas emission:	BS EN 50267-2-1; HCL < 0,5 %

CONSTRUCTION

Conductor:	plain annealed copper stranded circular or circular compacted conductor class 2 according to BS EN 60228
Insulation:	XLPE compound type GP8 according to BS 7655-1.3
Sheath:	halogen-free thermoplastic compound type LTS1 according to BS 7655-6.1

CHARACTERISTIC

Colour of sheath:	Black
Colour of insulation:	brown or blue
Maximum conductor operating temperature:	+90°C
Lowest installation temperature:	-15°C
Maximum short-circuit conductor temperature:	+250°C
Minimum bending radius:	6D; D - overall cable diameter
Application:	for fixed installation in dry or damp areas for domestic and light industrial wiring. Particularly for situations in which low emission of smoke and corrosive gases is required in case of burning. These cables are not intended to provide circuit integrity in case of fire.
Standard packing:	500 m on drums. Other forms of packing and delivery are available on request.

Number and cross-sectional area of conductors		Class of conductor	Nominal thickness of insulation	Nominal thickness of sheath	Approximate overall diameter	Approximate net weight of cables	Maximum resistance of conductor at 20°C
n x mm ²			mm	mm	mm	kg/km	mm ²
1	x 50	2	1,0	1,4	13,3	518	0,387
1	x 70	2	1,1	1,4	14,8	719	0,268
1	x 95	2	1,1	1,5	17,0	978	0,193
1	x 120	2	1,2	1,5	18,6	1214	0,153
1	x 150	2	1,4	1,6	20,8	1498	0,124
1	x 185	2	1,6	1,6	22,7	1853	0,0991
1	x 240	2	1,7	1,7	25,6	2394	0,0754
1	x 300	2	1,8	1,8	27,8	2978	0,0601
1	x 400	2	2,0	1,9	32,0	3852	0,0470
1	x 500	2	2,2	2,0	34,9	4896	0,0366
1	x 630	2	2,4	2,2	39,9	6235	0,0283

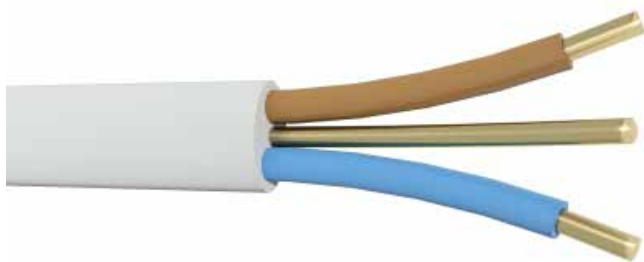

Thermosetting insulated and LSOH sheathed flat cable with circuit protective conductor

FIRE PERFORMANCE

Flame propagation:	EN 60332-1-2 (IEC 60332-1)
Smoke emission:	EN 61034-2 (IEC 61034-2)
Corrosive and acid gas emission of insulation:	EN 50267-2-2 (IEC 60754-2): pH ≥ 4,3; Conductivity: ≤ 10 μS/mm

CONSTRUCTION

Conductor:	annealed copper, class 1 solid (H07Z-U), class 2 stranded (H07Z-R) or class 5 flexible (H07Z-K) according to EN 60228
Insulation:	special thermosetting, low smoke, zero halogen compound type EI5, according to EN 50363-5

CHARACTERISTIC

Colour of insulation:	green/yellow, black, blue, brown, grey, orange, pink, red, white or other colours.			
Minimum bending radius:	For cable diameter D (mm)			
	D ≤ 8	8 < D ≤ 12	12 < D ≤ 20	D > 20
Normal use	4 D	5 D	6 D	6 D
Careful bending at termination	2 D	3 D	4 D	4 D
Maximum conductor operating temperature:	+90°C			
Lowest ambient temperature for fixed installation (static):	-40°C			
Lowest installation temperature (flexing):	-5°C			
Maximum short-circuit temperature:	+250°C			
Test voltage 50Hz:	2500V			
Application:	when low emission of smoke and corrosive gases is required in case of burning. Intended for installation in surface mounted or embedded conduits, or similar closed systems. Suitable for fixed protected installation in, or on, lighting and control gear for voltages up to 1000 V AC or, up to 750V DC to earth.			
Standard packing:	100 m in coils or on spools, or 500 m on drums. Other forms of packing and delivery are available on request.			

Number and cross-sectional area of conductors		Number of wires in conductor	Nominal thickness of insulation	Nominal thickness of sheath	Approximate overall dimensions		Approximate net weight of cables	Nominal cross-sectional area of circuit protective conductor	Number of wires in circuit protective conductor
n x mm ²		n	mm	mm	mm		kg/km	mm ²	N
2	x 1	1	0,7	0,9	4,3	x 7,9	63	1,0	1
2	x 1	7	0,7	0,9	4,5	x 8,3	66	1,0	1
2	x 1,5	1	0,7	0,9	4,6	x 8,4	75	1,0	1
2	x 1,5	7	0,7	0,9	4,8	x 8,8	79	1,0	1
2	x 2,5	1	0,7	1,0	5,1	x 9,6	106	1,5	1
2	x 2,5	7	0,7	1,0	5,4	x 10,1	112	1,5	1
2	x 4	7	0,7	1,0	5,9	x 11,2	146	1,5	1
2	x 6	7	0,7	1,1	6,5	x 12,5	200	2,5	1
2	x 10	7	0,7	1,2	7,6	x 15,3	311	4	7
2	x 16	7	0,7	1,3	8,8	x 17,9	461	6	7
3	x 1	1	0,7	0,9	4,3	x 10,4	84	1,0	1
3	x 1,5	1	0,7	0,9	4,6	x 11,2	102	1,0	1
3	x 2,5	1	0,7	1,0	5,1	x 12,5	140	1,0	1
3	x 4	7	0,7	1,0	5,9	x 15,1	205	1,5	1
3	x 6	7	0,7	1,1	6,5	x 16,8	279	2,5	1
3	x 10	7	0,7	1,2	7,6	x 20,5	434	4	7
3	x 16	7	0,7	1,3	8,8	x 24,1	647	6	7

Conductors Cross-Sectional Area	Two core cable DC	Two core cable Single phase AC	Three or four cable Three phase AC
mm ²	mV/A/m	mV/A/m	mV/A/m
1	46	46	40
1,5	31	31	27
2,5	19	19	16
4	12	12	10
6	7,9	7,9	6,8
10	4,7	4,7	4,0
16	2,9	2,9	2,5

The above table is in accordance with Table 4E2B of the 17th Edition of IEE Wiring Regulations.

Conductors Cross-Sectional Area	Reference Method A (enclosed in conduit in thermally insulated wall)		Reference Method B (enclosed in conduit on a wall or in trunking)		Reference Method C (clipped direct)		Reference Method E (on a perforated cable tray or in free air) Horizontal or vertical	
	1 two-core cable, single-phase AC or DC	1 three- or 1 four-core cable, three-phase AC	1 two-core cable, single-phase AC or DC	1 three- or 1 four-core cable, three-phase AC	1 two-core cable, single-phase AC or DC	1 three- or 1 four-core cable, three-phase AC	1 two-core cable, single-phase AC or DC	1 three- or 1 four-core cable, three-phase AC
mm ²	Amps							
1	14,5	13	17	15	19	17	21	18
1,5	18,5	16,5	22	19,5	24	22	26	23
2,5	25	22	30	26	33	30	36	32
4	33	30	40	35	45	40	49	42
6	42	38	51	44	58	52	63	54
10	57	51	69	60	80	71	86	75
16	76	68	91	80	107	96	115	100

FLAMEB LOCKER UK REF. 318(*)B 300/500V

Based on BS 7211 BS 6500, BS 7919

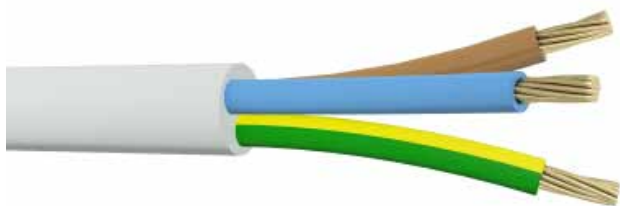

**LSOH insulated
and sheathed
flexible cords**

FIRE PERFORMANCE

Flame propagation:	BS EN 60332-1-2 (IEC 60332-1-2)
Smoke density:	BS EN 61034-2 (IEC 61034-2)
Gases evolved during combustion:	BS EN 50267-2-1 (IEC 60754-1): HCL \leq 0,5 % BS EN 50267-2-2 (IEC 60754-2): pH \geq 4,3; conductivity \leq 10 μ S/mm

CONSTRUCTION

Conductor:	annealed copper, class 5 flexible conductor according to BS EN 60228
Insulation:	special thermoplastic compound LSOH (Low Smoke Zero Halogen)
Sheath:	special thermoplastic compound LSOH (Low Smoke Zero Halogen)

CHARACTERISTIC

Colour of sheath:	White
Colour of insulation:	according to HD 308 S2
twin core:	blue and brown
3-core:	green/yellow, blue, brown
4-core:	green/yellow, brown, black, grey
5-core:	green/yellow, blue, brown, black, grey
Maximum conductor operating temperature:	+60°C
Lowest ambient temperature for fixed installation:	-30°C
Lowest installation temperature:	-5°C
Maximum short-circuit conductor temperature:	+150°C
Test voltage 50Hz:	2000V
Minimum bending radius:	6 x cable diameter
Application:	In domestic premises, kitchens, and offices; for household appliances, including in damp premises; for medium duties (e.g. washing machines, spin dryers, and refrigerators). Particularly for situations in which low emission of smoke and corrosive gases is required in case of burning.
Standard packing:	100 m on spools or 500 m on drums. Other forms of packing and delivery are available on request.

Number and cross-sectional area of conductor			Maximum diameter of wires in conductor	Nominal thickness of insulation	Nominal thickness of sheath	Approximate overall diameter	Approximate net weight of cables	Maximum conductor resistance at temperature 20°C
n x mm ²			mm	mm	mm	mm	kg/km	Ω/km
2	x	0,75	0,21	0,6	0,8	6,2	58	26,0
2	x	1	0,21	0,6	0,8	6,4	64	19,5
2	x	1,5	0,26	0,7	0,8	7,4	87	13,3
2	x	2,5	0,26	0,8	1,0	9,2	136	7,98
2	x	4	0,31	0,8	1,1	10,3	182	4,95
3	x	0,75	0,21	0,6	0,8	6,6	68	26,0
3	x	1	0,21	0,6	0,8	6,7	76	19,5
3	x	1,5	0,26	0,7	0,9	8,0	109	13,3
3	x	2,5	0,26	0,8	1,1	9,9	168	7,98
3	x	4	0,31	0,8	1,2	11,1	228	4,95
4	x	0,75	0,21	0,6	0,8	7,2	81	26,0
4	x	1	0,21	0,6	0,9	7,6	96	19,5
4	x	1,5	0,26	0,7	1,0	9,0	136	13,3
4	x	2,5	0,26	0,8	1,1	10,8	204	7,98
4	x	4	0,31	0,8	1,2	12,2	279	4,95
5	x	0,75	0,21	0,6	0,9	8,0	103	26,0
5	x	1	0,21	0,6	0,9	8,4	120	19,5
5	x	1,5	0,26	0,7	1,1	10,1	172	13,3
5	x	2,5	0,26	0,8	1,2	12,1	256	7,98
5	x	4	0,31	0,8	1,4	13,7	355	4,95



XLPE insulated and LSOH sheathed power cable

FIRE PERFORMANCE

Flame retardant	IEC 60332-3-24 C
Smoke density:	IEC 61034-2: light transmittance values > 70%
Gases evolved during combustion:	HD 602, IEC 60754-2: pH ≥ 4,3; conductivity ≤ 100 μS/cm

CONSTRUCTION

Conductors:	annealed copper solid class 1 (RE) – FR-N1X1G1-U, circular or circular compacted stranded conductor class 2 (RM, RMC) – FR-N1X1G1-R or sector-shaped class 2 (SM) acc. to EN 60228
Insulation:	special XLPE compound
Inner covering:	filling compound
Sheath:	special LSOH compound

CHARACTERISTIC

Colour of sheath:	Green RAL 6018 (without UV)	
Colour code:	HD 308 S2	
Number of core:	with protective conductor – G	without protective conductor – X
1 - core		black
twin		blue, brown
3 – core	green-yellow, blue, brown	brown, black, grey
4 – core	green-yellow, brown, black, grey	blue, brown, black, grey
5 - core	green-yellow, blue, brown, black, grey	blue, brown, black, grey, black
7 and more	green-yellow, other cores with numbering	with numbering
Maximum conductor operating temperature:	+90°C	
Lowest ambient temperature for fixed installation:	-30°C	
Lowest installation temperature:	0°C	
Maximum short-circuit conductor temperature:	+ 250μC	
Minimum bending radius:	12 x D, D – overall diameter	
Max. permissible tensile stress with cable grip for Cu-conductor:	50 N/mm ²	
Application:	XLPE insulated and LSOH sheathed power cables for the supply of electrical energy. Special for installations in the open air, indoors, in cable ducts.	
Standard length cable packing:	1000 or 500 m on drums. Other forms of packing and delivery are available on request.	

Number and cross-sectional area of conductor			number of wires in conductor	Nominal thickness of insulation	Nominal thickness of sheath	Approximate overall diameter	Approximate net weight of cables	Maximum conductor resistance at temperature 20°C
n x mm ²			n	mm	mm	mm	kg/km	W/km
1	x	10RMC	7	0,7	1,8	8,0	140	1,83
1	x	16RMC	7	0,7	1,8	9,0	200	1,15
2	x	1,5RE	1	0,7	1,8	9,5	129	12,1
2	x	1,5RM	7	0,7	1,8	9,9	138	12,1
2	x	2,5RE	1	0,7	1,8	10,3	162	7,41
2	x	2,5RM	7	0,7	1,8	10,8	174	7,41
2	x	4RE	1	0,7	1,8	11,2	207	4,61
2	x	4RM	7	0,7	1,8	11,8	223	4,61
3	x	1,5RE	1	0,7	1,8	9,9	146	12,1
3	x	1,5RM	7	0,7	1,8	10,4	156	12,1
3	x	2,5RE	1	0,7	1,8	10,8	187	7,41
3	x	2,5RM	7	0,7	1,8	11,3	199	7,41
3	x	4RE	1	0,7	1,8	11,8	245	4,61
3	x	4RM	7	0,7	1,8	12,4	261	4,61
3	x	6RMC	7	0,7	1,8	13,4	335	3,08
3	x	10RMC	7	0,7	1,8	15,4	487	1,83
3	x	16RMC	7	0,7	1,8	18,0	718	1,15
4	x	1,5RE	1	0,7	1,8	10,7	170	12,1
4	x	1,5RM	7	0,7	1,8	11,1	180	12,1
4	x	2,5RE	1	0,7	1,8	11,6	221	7,41
4	x	2,5RM	7	0,7	1,8	12,2	235	7,41
4	x	4RE	1	0,7	1,8	12,9	300	4,61
4	x	4RM	7	0,7	1,8	13,6	320	4,61
4	x	6RMC	7	0,7	1,8	14,5	405	3,08
4	x	10RMC	7	0,7	1,8	16,9	605	1,83
4	x	16RMC	7	0,7	1,8	19,6	884	1,15
5	x	1,5RE	1	0,7	1,8	11,5	199	12,1
5	x	1,5RM	7	0,7	1,8	12,0	211	12,1
5	x	2,5RE	1	0,7	1,8	12,7	267	7,41
5	x	2,5RM	7	0,7	1,8	13,4	285	7,41
5	x	4RE	1	0,7	1,8	13,9	356	4,61
5	x	4RM	7	0,7	1,8	14,8	380	4,61
5	x	6RMC	7	0,7	1,8	15,7	484	3,08
5	x	10RMC	7	0,7	1,8	18,4	730	1,83
5	x	16RMC	7	0,7	1,8	21,3	1070	1,15
7	x	1,5RE	1	0,7	1,8	12,5	246	12,1
7	x	2,5RE	1	0,7	1,8	13,6	327	7,41
12	x	1,5RE	1	0,7	1,8	15,9	385	12,1
19	x	1,5RE	1	0,7	1,8	18,2	533	12,1
27	x	1,5RE	1	0,7	1,8	21,6	728	12,1
37	x	1,5RE	1	0,7	1,8	23,9	930	12,1



XLPE insulated,
LSOH sheathed,
round wire armoured
cables

FIRE PERFORMANCE

Flame propagation:	BS EN 60332-1-2 and BS EN 50266-2-4 Category C
Smoke emission:	BS EN 61034-2
Corrosive and acid gas emission:	BS EN 50267-2-1, HCL ≤ 0,5%

CONSTRUCTION

Conductors:	annealed copper conductor, circular, circular compacted or shaped stranded class 2 according to BS EN 60228
Insulation:	cross-linked polyethylene XLPE type GP8 according to BS 7655-1.3
Bedding:	LSOH (special low smoke zero halogen compound)
Armour:	for single-core cables – single layer of aluminium wires applied spirally over the bedding (AWA) for two or more cores cables – single layer of galvanized steel wires applied spirally over the bedding (SWA)
Outer sheath:	black LSOH compound type LTS1 according to BS 7655-6.1

CHARACTERISTIC

Core identification:

1-core:	brown or blue
2-core:	brown, blue
3-core:	brown, black, grey
4-core:	blue, brown, black, grey
5-core	green/yellow, blue, brown, black, grey
auxiliary cables	white with black numbering

Maximum conductor operating temperature:	+90°C
Lowest installation temperature:	0°C
Maximum short-circuit conductor temperature:	+250°C
Minimum bending radius:	6D for cables with circular copper conductors and 8D for cables with shaped copper conductors; D – overall cable diameter
Application:	For use in fixed installations in industrial areas, buildings and similar applications.

Number and cross-sectional area of conductor			Nominal thickness of insulation	Thickness of extruded bedding	Nominal aluminium armour wire diameter	Nominal thickness of outer sheath	Approximate overall diameter	Approximate net weight of cables	Maximum conductor resistance at 20°C	Maximum armour resistance at 20°C
n x mm ²			mm	mm	mm	mm	mm	kg/km	W/km	W/km
1	x	150	1,4	1,0	1,6	1,7	25,6	1847	0,124	0,42
1	x	185	1,6	1,0	1,6	1,8	27,7	2246	0,0991	0,38
1	x	240	1,7	1,0	1,6	1,8	30,4	2817	0,0754	0,34
1	x	300	1,8	1,0	1,6	1,9	32,6	3435	0,0601	0,31
1	x	400	2,0	1,2	2,0	2,0	39,0	4479	0,0470	0,22
1	x	500	2,2	1,2	2,0	2,1	42,9	5593	0,0366	0,20
2	x	1,5	0,6	0,8	0,9	1,3	11,1	252	12,1	10,2
2	x	2,5	0,7	0,8	0,9	1,4	12,6	311	7,41	8,8
2	x	4	0,7	0,8	0,9	1,4	13,6	370	4,61	7,9
2	x	6	0,7	0,8	0,9	1,4	14,3	433	3,08	7,0
2	x	10	0,7	0,8	0,9	1,5	16,4	558	1,83	6,0
2	x	16	0,7	0,8	1,25	1,5	19,1	833	1,15	3,7
2	x	25	0,9	0,8	1,25	1,6	22,7	1134	0,727	3,7
2	x	35	0,9	1,0	1,6	1,7	26,1	1593	0,524	2,6
3	x	1,5	0,6	0,8	0,9	1,3	11,5	278	12,1	9,5
3	x	2,5	0,7	0,8	0,9	1,4	13,1	354	7,41	8,2
3	x	4	0,7	0,8	0,9	1,4	14,2	428	4,61	7,5
3	x	6	0,7	0,8	0,9	1,4	15,4	516	3,08	6,7
3	x	10	0,7	0,8	1,25	1,5	17,9	780	1,83	4,0
3	x	16	0,7	0,8	1,25	1,6	20,3	1023	1,15	3,5
3	x	25	0,9	1,0	1,6	1,7	25,2	1612	0,727	2,5
3	x	35 ¹⁾	0,9	1,0	1,6	1,8	27,7	1997	0,524	2,3
3	x	35 ²⁾	0,9	1,0	1,6	1,8	26,2	1939	0,524	2,3
3	x	50	1,0	1,0	1,6	1,8	28,8	2402	0,387	2,0
3	x	70	1,1	1,0	1,6	1,9	32,8	3158	0,268	1,8
3	x	95	1,1	1,2	2,0	2,1	37,5	4355	0,193	1,3
3	x	120	1,2	1,2	2,0	2,2	40,7	5222	0,153	1,2
3	x	150	1,4	1,4	2,5	2,3	46,3	6709	0,124	0,78
3	x	185	1,6	1,4	2,5	2,4	50,4	8029	0,0991	0,71
3	x	240	1,7	1,4	2,5	2,6	55,7	9990	0,0754	0,63
4	x	1,5	0,6	0,8	0,9	1,3	12,3	318	12,1	8,8
4	x	2,5	0,7	0,8	0,9	1,4	14,0	405	7,41	7,7
4	x	4	0,7	0,8	0,9	1,4	15,2	495	4,61	6,8
4	x	6	0,7	0,8	1,25	1,5	17,5	719	3,08	4,3
4	x	10	0,7	0,8	1,25	1,5	19,2	920	1,83	3,7
4	x	16	0,7	0,8	1,25	1,6	21,9	1230	1,15	3,1
4	x	25	0,9	1,0	1,6	1,7	27,3	1942	0,727	2,3
4	x	35 ¹⁾	0,9	1,0	1,6	1,8	30,0	2419	0,524	2,0
4	x	35 ²⁾	0,9	1,0	1,6	1,8	29,7	2411	0,524	2,0
4	x	50	1,0	1,0	1,6	1,9	32,9	3028	0,387	1,8
4	x	70	1,1	1,2	2,0	2,1	38,9	4347	0,268	1,2
4	x	95	1,1	1,2	2,0	2,2	43,1	5539	0,193	1,1
4	x	120	1,2	1,4	2,5	2,3	48,5	7183	0,153	0,76
4	x	150	1,4	1,4	2,5	2,4	52,9	8523	0,124	0,68

Number and cross-sectional area of conductor			Nominal thickness of insulation	Thickness of extruded bedding	Nominal aluminium armour wire diameter	Nominal thickness of outer sheath	Approximate overall diameter	Approximate net weight of cables	Maximum conductor resistance at 20°C	Maximum armour resistance at 20°C
n x mm ²			mm	mm	mm	mm	mm	kg/km	W/km	W/km
4	x	185	1,6	1,4	2,5	2,6	57,9	10274	0,0991	0,61
4	X	240	1,7	1,6	2,5	2,7	64,5	12902	0,0754	0,54
5	x	1,5	0,6	0,8	0,9	1,4	13,2	359	12,1	8,2
5	x	2,5	0,7	0,8	0,9	1,4	14,9	457	7,41	6,8
5	x	4	0,7	0,8	0,9	1,5	16,6	577	4,61	6,2
5	x	6	0,7	0,8	1,25	1,5	18,8	823	3,08	3,9
5	x	10	0,7	0,8	1,25	1,6	20,9	1081	1,83	3,4
5	x	16	0,7	1,0	1,6	1,7	24,9	1645	1,15	2,2
7	x	1,5	0,6	0,8	0,9	1,4	14,1	417	12,1	7,5
7	x	2,5	0,7	0,8	0,9	1,4	16,0	544	7,41	6,3
7	x	4	0,7	0,8	1,25	1,5	18,4	800	4,61	4,0
12	x	1,5	0,6	0,8	1,25	1,5	18,2	711	12,1	4,0
12	x	2,5	0,7	0,8	1,25	1,6	21,0	932	7,41	3,5
12	x	4	0,7	1,0	1,6	1,6	24,2	1364	4,61	2,3
19	x	1,5	0,6	0,8	1,25	1,6	20,7	916	12,1	3,5
19	x	2,5	0,7	1,0	1,6	1,7	25,1	1423	7,41	2,3
19	x	4	0,7	1,0	1,6	1,7	27,8	1810	4,61	2,0
27	x	1,5	0,6	1,0	1,6	1,7	25,2	1366	12,1	2,3
27	x	2,5	0,7	1,0	1,6	1,8	29,3	1838	7,41	1,9
37	x	1,5	0,6	1,0	1,6	1,7	27,5	1648	12,1	2,0
37	x	2,5	0,7	1,2	1,6	1,8	32,1	2232	7,41	1,7
48	X	1,5	0,6	1,0	1,6	1,8	30,9	1991	12,1	1,8
48	X	2,5	0,7	1,2	2,0	2,0	37,6	3065	7,41	1,2

Environmental
health
& safety



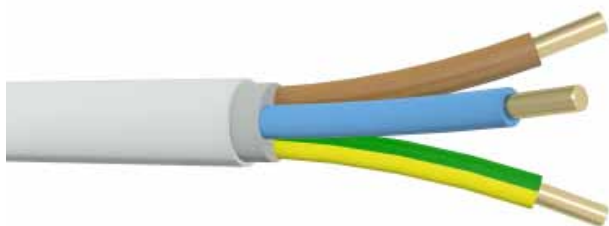

Halogen-free light sheathed cables with improved fire behaviour

FIRE PERFORMANCE

Flame propagation:	EN 50266-2-3, IEC 60332-3-23
Smoke density:	EN 61034-2, IEC 61034-2
Gases evolved during combustion:	EN 50267-2-1, IEC 60754-1: HCL ≤ 0,5% EN 50267-2-2, IEC 60754-2: pH ≥ 3,5; conductivity ≤ 100 μS/cm

CONSTRUCTION

Conductors:	plain annealed solid copper class 1 for 1,5 and 2,5 mm ² , stranded copper class 2 for 6 and 10 mm ² according to EN 60228, IEC 60228
Insulation:	special halogen-free thermoplastic polyolefin compound
Filling:	halogen-free filling compound
Sheath:	special halogen-free thermoplastic polyolefin compound

CHARACTERISTIC

Colour of sheath:	white	
Core identification HD 308 S2		
	with protective conductor (S)	without protective conductor (N)
twin	-	blue, brown
3-core	green/yellow, blue, brown	brown, black, grey
4-core	green/yellow, brown, black, grey	blue, brown, black, grey
5-core	green/yellow, blue, brown, black, grey	blue, brown, black, grey, black
Maximum conductor operating temperature:	+70°C	
Lowest recommended temperature during laying:	-15°C	
Maximum short-circuit conductor temperature:	+160°C	
Minimum bending radius:	10D; D(overall cable diameter)	
Application:	Installation cables for industrial complexes, public buildings, hotels, airports, hospitals or industrial plants with high concentration of people and/or property. The cable is halogen free and it features low density of smoke and toxic fumes in case of fire. Usable in the open, in dry, damp and wet environments in the open and concealed, as well as in masonry and in concrete. Not suitable for use in ground and water, for imbedding in solidified – or compressed – concrete.	
Standard packing:	500 m on drums. Other forms of packing and delivery are available on request.	

Number and cross-sectional area of conductor	Nominal thickness of insulation	Nominal thickness of sheath	Approximate overall diameter	Approximate net weight	Maximum conductor resistance at 20°C
n x mm ²	mm	mm	mm	kg/km	W/km
2 x 1,5	0,7	1,5	9,5	139	12,1
2 x 2,5	0,8	1,5	10,6	182	7,41
2 x 6	0,8	1,5	12,6	293	3,08
2 x 10	1,0	1,5	15,2	444	1,83
3 x 1,5	0,7	1,5	9,9	158	12,1
3 x 2,5	0,8	1,5	11,1	212	7,41
3 x 6	0,8	1,5	13,6	364	3,08
3 x 10	1,0	1,5	16,1	546	1,83
4 x 1,5	0,7	1,5	10,6	185	12,1
4 x 2,5	0,8	1,5	11,7	242	7,41
4 x 6	0,8	1,5	14,6	436	3,08
4 x 10	1,0	1,5	18,1	692	1,83
5 x 1,5	0,7	1,5	11,1	210	12,1
5 x 2,5	0,8	1,5	12,6	290	7,41
5 x 6	0,8	1,5	16,1	537	3,08
5 x 10	1,0	1,7	20,1	860	1,83

FLAMEBLOCKER EQQ LIGHT 300/500 V

Based on SS 424 02 19-3, HD 604-5D

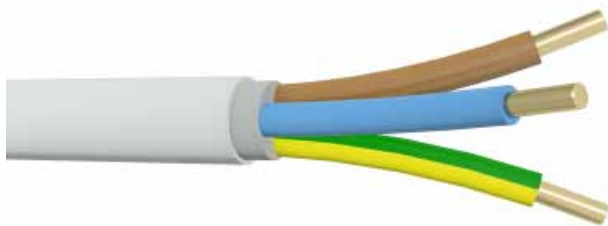

Halogen-free light sheathed cables with improved fire behaviour

FIRE PERFORMANCE

Flame propagation:	EN 60332-1-2, IEC 60332-1-2
Smoke density:	EN 61034-2, IEC 61034-2
Gases evolved during combustion:	EN 50267-2-2, IEC 60754-2: pH ≥ 4,3; conductivity ≤ 100 μS/cm

CONSTRUCTION

Conductor:	bare copper conductor, circular solid class 1 according to EN 60228, IEC 60228
Insulation:	thermoplastic halogen-free compound
Inner covering:	special halogen-free filling compound
Sheath:	thermoplastic halogen-free compound

CHARACTERISTIC

Colour of sheath:	White
Core identification:	according to HD 308 S2
2-core:	blue, brown
3-core:	green/yellow, blue, brown
4-core:	green/yellow, brown, black, grey
5-core:	green/yellow, blue, brown, black, grey
Maximum conductor operating temperature:	+70°C
Lowest ambient temperature for fixed installation:	-30°C
Maximum short-circuit conductor temperature:	+160°C
Test voltage 50Hz:	2000V
Minimum bending radius:	6D - (D - overall cable diameter)
Application:	Installation cables for industrial complexes, public buildings, hotels, airports, hospitals or industrial plants with high concentration of people and/or property. Cables may be laid in rooms and areas where dark smoke and corrosive fumes can give damage in case of a fire.
Standard packing:	500 m on drums. Other forms of packing and delivery are available on request.

Number and cross-sectional area of conductor			Nominal thickness of insulation	Nominal thickness of sheath	Approximate overall diameter	Approximate net weight of cables	Maximum conductor resistance at 20°C
n x mm ²			mm	mm	mm	kg/km	W/km
2	x	1,5	0,7	1,2	8,5	116	12,1
2	x	2,5	0,8	1,2	9,7	158	7,41
3	G	1,5	0,7	1,2	8,9	135	12,1
3	G	2,5	0,8	1,2	10,2	187	7,41
4	G	1,5	0,7	1,2	9,7	161	12,1
4	G	2,5	0,8	1,2	11,1	224	7,41
5	G	1,5	0,7	1,2	10,5	192	12,1
5	G	2,5	0,8	1,2	12,0	270	7,41

FLAMEBLOCKER EXQJ 0,6/1 kV

Based on SS 424 14 18, HD 603-3L, and HD 604 (halogen-free materials)



Halogen-free low
smoke power cables
with copper
concentric conductor

FIRE PERFORMANCE

Flame propagation:	EN 50266-2-4, IEC 60332-3-24
Smoke density:	EN 61034-2, IEC 61034-2
Gases evolved during combustion:	EN 50267-2, IEC 60754-2: pH \geq 4,3; conductivity \leq 10 μ S/mm

CONSTRUCTION

Conductors:	bare annealed copper conductor, circular solid class 1 according to EN 60228
Insulation:	cross-linked polyethylene XLPE type DIX3
Inner covering:	special flame-retardant and halogen-free compound
Concentric conductor:	inner layer - round copper wires, outer layer - copper tape
Separator:	tape
Sheath:	thermoplastic halogen - free polyolefin compound

CHARACTERISTIC

Colour of sheath:	black
Core identification:	according to HD 308 S2
2-core:	blue, brown
3-core:	brown, black, grey
4-core:	blue, brown, black, grey

The materials used in manufactures are cadmium - free and contain no silicone.

Maximum conductor operating temperature:	+90°C
Lowest ambient temperature for fixed installation:	-30°C
Lowest installation temperature:	-5°C
Maximum short-circuit conductor temperature:	+250°C
Minimum bending radius:	15D - for single core cable; 12D - for multicore cable (D - overall cable diameter)
Maximum permissible tensile stress with cable grip for Cu-conductor:	50 N/mm ² (total cross-section of the conductors, any screen not included)
Application:	for the supply of electrical energy, especially for installations where fire and emissions of smoke and toxic fumes create a potential threat.
Standard packing:	500 m on drums. Other forms of packing and delivery are available on request.

Number and cross-sectional area of conductor			Minimum number of wires in conductor	Nominal thickness of insulation	Nominal thickness of sheath	Approximate overall diameter	Approximate net weight of cables	Maximum conductor resistance at 20°C
n x mm ²			n	mm	mm	mm	kg/km	W/km
2	x	2,5/2,5	1	0,7	1,8	12,7	235	7,41 / 7,41
2	x	4/4	1	0,7	1,8	14,0	304	4,61 / 4,61
2	x	6/6	1	0,7	1,8	15,3	383	3,08 / 3,08
2	x	10/10	1	0,7	1,8	17,0	533	1,83 / 1,83
2	x	16/16	1	0,7	1,8	18,9	621	1,15 / 1,15
3	x	2,5/2,5	1	0,7	1,8	13,2	262	7,41 / 7,41
3	x	4/4	1	0,7	1,8	14,6	344	4,61 / 4,61
3	x	6/6	1	0,7	1,8	15,9	438	3,08 / 3,08
3	x	10/10	1	0,7	1,8	17,7	622	1,83 / 1,83
3	x	16/16	1	0,7	1,8	19,8	772	1,15 / 1,15
4	x	2,5/2,5	1	0,7	1,8	14,0	299	7,41 / 7,41
4	x	4/4	1	0,7	1,8	15,5	396	4,61 / 4,61
4	x	6/6	1	0,7	1,8	17,0	510	3,08 / 3,08
4	x	10/10	1	0,7	1,8	19,0	732	1,83 / 1,83
4	x	16/16	1	0,7	1,8	21,3	931	1,15 / 1,15

FLAMEBLOCKER FXQJ 0,6/1 kV

Based on SS 424 14 18, HD 603-5P



XLPE insulated cables with concentric conductor and LSOH sheath

FIRE PERFORMANCE

Flame propagation:	EN 50266-2-4, IEC 60332-3-24
Smoke density:	EN 61034-2, IEC 61034-2
Gases evolved during combustion:	EN 50267-2-2, IEC 60754-2: pH \geq 4,3; conductivity \leq 10 μ S/mm

CONSTRUCTION

Conductor:	copper circular compacted stranded conductor class 2 (RM) or stranded sector – shaped conductor class 2 (SM) according to EN 60228
Insulation:	XLPE compound type DIX3
Cable core:	Insulated conductors are twisted together with eventually central filler
Inner covering:	tape
Concentric conductor:	copper wires and copper tape helically wound overlapped by polyester tape
Outer sheath:	thermoplastic halogen – free polyolefin compound

CHARACTERISTIC

Colour of sheath:	black
Core identification:	according to HD 308.S2
3-core:	brown, black, grey
4-core:	blue, brown, black, grey

The materials used are cadmium-free and contain no silicone

Maximum conductor operating temperature:	+90°C
Maximum short-circuit conductor temperature:	+250°C
Test voltage of complete cable:	3,5 kV AC 50Hz, 5 min.
Minimum bending radius:	12D for multi conductor cables; D – overall cable diameter
Maximum permissible pulling force by cable stocking or by pulling-head:	50 N/mm ²
Application:	for the supply of electrical energy where fire and emissions of smoke and toxic fumes create a potential threat.
Standard packing:	500 m or 1000 m on drums. Other forms of packing and delivery are available on request.

Number and cross-sectional area of conductor			Nominal thickness of insulation	Thickness of outer sheath	Approximate overall diameter	Approximate weight of cables	Maximum conductor resistance at 20°C	Maximum concentric conductor resistance at 20°C
n x mm ²			mm	mm	mm	kg/km	W/km	W/km
3	x	16 RMC / 16	0,7	1,8	20,7	780	1,150	1,150
3	x	25 RMC / 16	0,9	1,8	24,3	1080	0,727	1,150
3	x	35 RMC / 16	0,9	1,8	26,6	1360	0,524	1,150
3	x	50 SM / 25	1,4	1,9	26,1	1795	0,387	0,727
3	x	70 SM / 35	1,1	2,0	30,2	2520	0,268	0,524
3	x	95 SM / 50	1,6	2,2	33,5	3405	0,193	0,387
3	x	150 SM / 70	1,8	2,4	40,6	5145	0,124	0,268
3	x	240 SM / 120	2,2	2,8	48,9	8310	0,0754	0,153
4	x	16 RMC / 16	0,7	1,8	22,3	950	1,150	1,150
4	x	25 RMC / 16	0,9	1,8	26,4	1330	0,727	1,150
4	x	35 RMC / 16	0,9	1,8	28,9	1715	0,524	1,150
4	x	50 SM / 25	1,4	2,0	29,4	2290	0,387	0,727
4	x	70 SM / 35	1,4	2,1	33,9	3215	0,268	0,727
4	x	95 SM / 50	1,6	2,3	37,7	4350	0,193	0,387
4	x	120 SM / 70	1,6	2,4	41,9	5500	0,153	0,268
4	x	150 SM / 70	1,8	2,6	45,8	6600	0,124	0,268
4	x	185 SM / 95	2,0	2,7	50,0	8250	0,0991	0,193
4	x	240 SM / 120	2,2	2,9	55,3	10655	0,0754	0,153

FLAMEBLOCKER AXQJ 0,6/1 kV

Based on SS 424 14 18, HD603-5P



XLPE insulated cables with concentric conductor and LSOH sheath

FIRE PERFORMANCE

Flame propagation:	EN 50266-2-4, IEC 60332-3-24
Smoke density:	EN 61034-2, IEC 61034-2
Gases evolved during combustion:	EN 50267, IEC 60754-2: pH \geq 4,3; conductivity \leq 10 μ S/mm

CONSTRUCTION

Conductor:	aluminium circular compacted stranded conductor class 2 (RM) or stranded sector – shaped conductor class 2 (SM) according to EN 60228
Insulation:	XLPE compound type DIX3
Cable core:	insulated conductors are twisted together with eventually central filler overlapped by polyester tape
Inner covering:	tape
Concentric conductor:	copper wires and copper tape helically wounded overlapped by polyester tape
Outer sheath:	thermoplastic halogen – free polyolefin compound

CHARACTERISTIC

Colour of sheath:	black
Core identification:	according to HD 308.S2
4-core:	blue, brown, black, grey
The materials used in manufactures are cadmium - free and contain no silicone.	
Maximum conductor operating temperature: :	+90°C
Maximum short-circuit conductor temperature:	+250°C
Test voltage of complete cable:	3,5 kV AC 50Hz , 5 min.
Minimum bending radius:	12D; D – overall cable diameter
Maximum permissible pulling force by cable stocking or by pulling-head:	30 N/mm ²
Application:	for the supply of electrical energy, especially for installations where fire and emissions of smoke and toxic fumes create a potential threat.
Standard packing:	500 m or 1000 m on drums. Other forms of packing and delivery are available on request.

Number and cross-sectional area of conductor			Nominal thickness of insulation	Thickness of outer sheath	Approximate overall diameter	Approximate weight of cables	Maximum conductor resistance at 20°C	Maximum concentric conductor resistance at 20°C
n x mm ²			mm	mm	mm	kg/km	W/km	W/km
4	x	50 SM / 15	1,0	2,0	29,3	1060	0,641	1,20
4	x	70 SM / 21	1,1	2,1	33,5	1440	0,443	0,868
4	x	95 SM / 29	1,1	2,3	37,7	1900	0,320	0,641
4	x	150 SM / 41	1,4	2,6	45,9	2830	0,206	0,443
4	x	185 SM / 57	1,6	2,7	50,3	3530	0,164	0,320
4	x	240 SM / 72	1,7	2,9	56,5	4480	0,125	0,253

Quality
makes
priority



Single conductor
rubber insulated
and sheathed flexible
power cables



FIRE PERFORMANCE

Flame propagation:	DIN EN 60332-1-2
Smoke emission:	DIN EN 61034-2
Corrosive and acid gas emission:	DIN EN 50267-2-2, pH \geq 4,3; conductivity \leq 100 μ S/cm

CONSTRUCTION

Conductors:	annealed tinned copper conductor class 5 according to IEC 60228
Separator:	semi-conducting tape under insulation
Insulation:	EPR thermosetting compound type 3GI3 according to DIN VDE 0207-20
Outer sheath:	halogen free thermosetting compound type HM3 according to DIN VDE 0207-24

CHARACTERISTIC

Colour of outer sheath:	black
Features:	oil resisting, chemicals, flame retardant and weather resistant
Tests:	DIN VDE 0250
Temperature range:	for flexible use: -25 up to 90°C, for fixed installation: -40 up to 90°C
Minimum bending radius:	for flexible use: 10D, for fixed installation: 6D; (D – overall cable diameter)
Application:	for use in electrical installations at working voltages up to 1,8/3 kV, where low smoke in case of burning is required.
Standard packing:	500 m on drums. Other forms of packing and delivery are available on request.

Number and cross-sectional area of conductor	Nominal thickness of insulation	Nominal thickness of sheath	Overall diameter		Approximate net weight of cables	Voltage drop	Current-Carrying Capacity at 30°C in air**
			Approx.	Max.			
mm ²	mm	mm	mm		kg/kg	mV/(Am)	A
1 x 1,5	1,3	0,8	5,7	7,0	47	30,26	30
1 x 2,5	1,3	0,8	6,2	7,5	60	18,13	41
1 x 4	1,3	0,8	6,7	9,0	77	11,24	55
1 x 6	1,3	0,8	7,2	9,5	98	7,49	70
1 x 10	1,5	0,8	8,6	11,0	149	4,31	98
1 x 16	1,5	0,8	10,7	13,0	222	2,74	132
1 x 25	1,8	1,0	12,9	15,0	333	1,76	176
1 x 35	1,8	1,0	13,6	16,5	425	1,26	218
1 x 50	1,8	1,0	15,6	18,0	576	0,88	276
1 x 70	1,8	1,0	17,2	20,5	770	0,63	347
1 x 95	2,2	1,0	19,0	24,0	1002	0,49	416
1 x 120	2,2	1,0	21,5	26,0	1255	0,39	488
1 x 150	2,2	1,2	23,4	28,0	1553	0,33	566
1 x 185	2,4	1,2	24,5	31,0	1853	0,28	644
1 x 240	2,6	1,2	28,9	34,5	2409	0,23	775
1 x 300	2,8	1,2	29,9	38,0	2938	0,21	898
1 x 500*	3,4	1,6	39,8	46,0	4908	0,16	1250

* - based on Standard,

** - Tab.15 DIN VDE 0298-4:2003. For Rother temperature use Tab. 17 Column 7. Conductor operating temperature 90°C

Single conductor rubber insulated and sheathed flexible power cables



FIRE PERFORMANCE

Flame propagation:	DIN EN 60332-1-2
Smoke emission:	DIN EN 61034-2
Corrosive and acid gas emission:	DIN EN 50267-2-2, pH ≥ 4,3; conductivity ≤ 100 µS/cm

CONSTRUCTION

Conductors:	annealed tinned copper conductor class 5 according to IEC 60228
Separator:	semi-conducting tape under insulation
Insulation:	EPR thermosetting compound type 3GI3 according to DIN VDE 0207-20
Outer sheath:	halogen free thermosetting compound type HM3 according to DIN VDE 0207-24

CHARACTERISTIC

Colour of outer sheath:	black
Features:	oil resisting, chemicals, flame retardant and weather resistant
Tests:	DIN VDE 0250
Temperature range:	for flexible use: -25 up to 90°C, for fixed installation: -40 up to 90°C
Minimum bending radius:	for flexible use: 10D, for fixed installation: 6D; (D – overall cable diameter)
Application:	for use in electrical installations at working voltages up to 3.6/6 kV, where low smoke in case of burning is required.
Standard packing:	500 m on drums. Other forms of packing and delivery are available on request.

Number and cross-sectional area of conductor	Nominal thickness of insulation	Nominal Thickness of sheath	Overall diameter		Approximate net weight of cables	Maximum conductor resistance at 20°C	Current-Carrying Capacity at 30°C in air**
			Approx.	Max			
mm ²	mm	mm	mm		kg/kg	Ω/km	A
1 x 1.5	2,6	0,8	8,3	10,5	88	13,7	32
1 x 2.5	2,6	0,8	8,8	11,5	103	8,21	43
1 x 4	2,6	0,8	9,7	12,0	130	5,09	56
1 x 6	2,6	0,8	10,2	13,0	155	3,39	71
1 x 10	2,6	0,8	11,6	14,5	215	1,95	99
1 x 16	2,6	1,0	12,7	15,5	283	1,24	133
1 x 25	2,9	1,0	14,5	17,5	393	0,795	174
1 x 35	2,9	1,0	15,2	19,0	489	0,565	215
1 x 50	2,9	1,0	17,2	21,0	651	0,393	270
1 x 70	2,9	1,0	19,0	23,0	856	0,277	338
1 x 95	3,2	1,0	21,7	26,5	1109	0,210	403
1 x 120	3,2	1,0	23,2	28,5	1369	0,164	473
1 x 150	3,2	1,2	25,0	30,5	1652	0,132	546
1 x 185	3,2	1,2	27,3	33,0	1965	0,108	622
1 x 240*	3,2	1,2	29,6	34,0	2526	0,0817	-

*Based on Standard

**Tab. 15 DIN VDE 0298-4:2003. For other temperature use Tab. 17 Column 7.

Incessant communication





CHAPTER 3

FLAME-X 950 JE-H(St)H...Bd FE180/E90	126
FlameBlocker JE-H(St)H ... Bd	128
FlameBlocker J-H(St)H ...Bd	130
FlameBlocker LiHH, LiHCH	132

Fire Resistant, Flame Retardant, Halogen Free, Low Smoke Data Cables

Cables are manufactured with the use of halogen-free materials. These materials exhibit better fire performance, have improved resistance to flame propagation and can extinguish flame spread through the cable. Cables have low emission of smoke and corrosive gases when affected by fire.

Application:

Cables are used for the telephone transmission, measurement and control technology. Installed in locations of increased fire safety requirements, where large agglomeration of people and cultural or material goods of high value are present: schools, hospitals, shopping centers, airports, hotels, supermarkets, underground tunnels, multi-storey buildings, stations of underground railways, underground garages, sports and show halls, stadiums, cinemas, theatres, museums, office buildings, educational centers, industrial complexes.

Tested and approved by:

VDE (Verband der Elektrotechnik)

Halogen-free low smoke fire resistant wiring cables for telecommunication and data processing systems

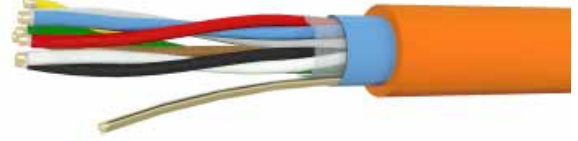

FIRE PERFORMANCE

Insulation integrity FE 180:	DIN VDE 0472-814 (800oC, 180 minutes), IEC 60331
System integrity E90:	DIN 4102-12 (90 min.)
Flame propagation:	VDE 0482-266-2-4, DIN EN 50266-2-4, IEC 60332-3-24
Smoke density:	VDE 0482-1034-2, DIN EN 61034-2, IEC 61034-2
Gases evolved during combustion:	VDE 0482-267-2-2, DIN EN 50267-2-2, IEC 60754-2: pH ≥ 3,5; conductivity ≤ 100 μS cm ⁻¹

CONSTRUCTION

Conductors:	bare solid copper conductor 0,8 mm
Insulation:	special core insulation with mica tape and halogen-free cross-linked compound type HI1 according to DIN VDE 0266
Pair:	two cores twisted to pair and each 4 pairs consist to unit
Separator:	polyester tape
Screen:	aluminium/polyester laminated tape and solid copper drain wire
Drain wire:	solid tinned annealed copper wire 0,8 mm
Sheath:	thermoplastic halogen-free, flame retardant compound according to DIN EN 50290-27 (DIN VDE 0207-24)

CHARACTERISTIC

Colour of sheath:	grey, orange or red		
Identification of pairs:	Pair no.	a-wire	b-wire
	1	blue	red
	2	grey	yellow
	3	green	brown
	4	white	black

Two-pair cables shall be cabled in quad formation and colour coded: blue, yellow, red, grey

Operating voltage:	peak voltage max. 225V (not for purposes of high current and power installation)
Loop resistance:	maximum 73,2 Ω/km
Insulation resistance at temperature 20oC:	minimum 100 MΩ x km
Mutual capacitance:	maximum 120 nF/km at 800 Hz (this values may be extended at 20% with a make-up up to 4 pairs)
Capacitance unbalance:	maximum 200 pF/100 m at 800 Hz (20% of the values, but one value up to 400 pF is allowed)
Test voltage 50 Hz:	core/core – 500V; core/screen – 2000V
Temperature range:	flexing: - 5°C to + 50°C, fixed installation - 30°C to + 70°C
Minimum bending radius:	6D (D - overall cable diameter)

Application:

Fire resistant, halogen-free static screened installation cables for telecommunication purpose. The static screen prevents strong interference impulse. Suitable for fixed installation everywhere, where in case of fire human life and material assets are to be protected, e.g. in industrial complexes, public buildings, hotels, airports, underground railway networks, hospitals. Not for purposes of high current and power installation.

Standard packing:

500 m on drums. Other forms of packing and delivery are available on request.

Number pairs and diameter of conductor	Approximate overall diameter	Approximate net weight of cable
n x 2 x mm	mm	kg/km
1 x 2 x 0,8	10,5	105
2 x 2 x 0,8	11,9	151
4 x 2 x 0,8	18,3	277

Halogen-free low smoke installation cables for telecommunication and data processing systems

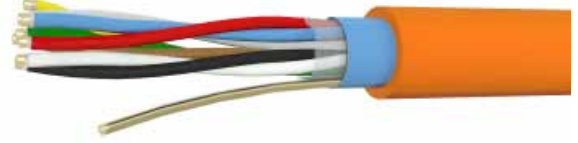

FIRE PERFORMANCE

Flame propagation:	VDE 0482-266-2-4, DIN EN 50266-2-4 (IEC 60332-3-24 Category C)
Smoke density:	VDE 0482-1034-2, DIN EN 61034-2 (IEC 61034-2)
Gases evolved during combustion:	VDE 0482-267-2-2, DIN EN 50267-2-2 (IEC 60754-2: pH ≥ 3,5; conductivity ≤ 100 μS cm ⁻¹)

CONSTRUCTION

Conductors:	bare solid copper conductor 0,6 and 0,8 mm
Insulation:	special halogen-free compound according to DIN EN 50290-2-26 (DIN VDE 0207-23)
Unit:	core twisted to pairs, 4 pairs consist to unit, units stranded to layers
Separator:	polyester tape
Screen:	aluminium/polyester laminated tape and solid copper drain wire
Drain wire:	solid tinned annealed copper wire 0,6 or 0,8 mm
Sheath:	thermoplastic halogen-free, flame retardant compound according to DIN EN 50290-27 (DIN VDE 0207-24)

CHARACTERISTIC

Colour of sheath:	grey, orange or red		
Identification of pairs:	Pair no.	a-wire	b-wire
	Loop 1	blue	red
	Loop 2	grey	yellow
	Loop 3	green	brown
	Loop 4	white	black
Binding tapes:	binding tapes with numerical marking of unit		
Identification two-pair cable:	two-pair cables shall be cabled in quad formation and colour coded: blue, yellow, red, grey		
	Pair no.	a-wire	b-wire
	Loop 1	blue	red
	Loop 2	grey	yellow
Loop resistance:	maximum 130 Ω/km at 0,6 mm 73,2 Ω/km at 0,8 mm		
Mutual capacitance:	max. 120 nF/km at 800 Hz (this values may be extended at 20% with a make-up up to 4 pairs)		
Capacitance unbalance:	max. 200 pF/100 m at 800 Hz (20% of the values, but one value up to 400 pF is allowed)		
Mutual capacitance:	max. 120 nF/km at 800 Hz		
Capacitance unbalance:	max. 200 pF/100 m at 800 Hz		

FLAMEB LOCKER JE-H(St)H ... Bd

Based on DIN VDE 0815

Operating voltage (peak voltage)	225V (not for purposes of high current and power installations)
Temperature range:	
flexing::	-5°C to +50°C
fixed installation	-30°C to +70°C
Minimum bending radius:	6D (D - overall cable diameter)
Application:	for signal transmission. The cables are preferably used for indoor telecommunication installation in dry and damp places, but also in the open for fixed installation on outer walls of buildings.
Standard packing:	500 m on drums. Other forms of packing and delivery are available on request.

Number pairs and diameter of conductor	Approximate overall diameter	Approximate net weight of cable	Number pairs and diameter of conductor	Approximate overall diameter	Approximate net weight of cable
n x 2 x mm	mm	kg/km	n x 2 x mm	mm	kg/km
2 x 2 x 0,6	5,5	44	2 x 2 x 0,8	6,5	62
4 x 2 x 0,6	6,6	65	4 x 2 x 0,8	8,1	95
8 x 2 x 0,6	8,3	101	8 x 2 x 0,8	10,4	156
12 x 2 x 0,6	9,6	135	12 x 2 x 0,8	12,2	214
16 x 2 x 0,6	10,5	167	16 x 2 x 0,8	13,9	283
20 x 2 x 0,6	11,5	199	20 x 2 x 0,8	15,2	340
24 x 2 x 0,6	12,3	231	24 x 2 x 0,8	16,3	396
28 x 2 x 0,6	13,2	273	28 x 2 x 0,8	17,0	448
32 x 2 x 0,6	13,9	304	32 x 2 x 0,8	18,4	521
36 x 2 x 0,6	14,6	335	36 x 2 x 0,8	19,3	576
40 x 2 x 0,6	15,2	366	40 x 2 x 0,8	20,1	630
44 x 2 x 0,6	15,8	396	44 x 2 x 0,8	20,9	684
48 x 2 x 0,6	16,4	426	48 x 2 x 0,8	21,7	737
52 x 2 x 0,6	16,9	456	52 x 2 x 0,8	22,5	791
56 x 2 x 0,6	17,4	486	56 x 2 x 0,8	23,2	844
60 x 2 x 0,6	17,9	517	60 x 2 x 0,8	24,3	924
64 x 2 x 0,6	18,8	566	64 x 2 x 0,8	25,0	978
68 x 2 x 0,6	19,3	595	68 x 2 x 0,8	25,6	1032
72 x 2 x 0,6	19,8	626	72 x 2 x 0,8	26,2	1085
76 x 2 x 0,6	20,2	655	76 x 2 x 0,8	26,9	1138
80 x 2 x 0,6	20,6	685	80 x 2 x 0,8	27,5	1191

FLAMEB LOCKER J-H(St)H ...Bd

Based on DIN VDE 0815

Halogen-free low smoke installation cables for telecommunication and data processing systems



FIRE PERFORMANCE

Flame propagation:	VDE 0482-266-2-4, DIN EN 50266-2-4 (IEC 60332-3-24 Category C)
Smoke density:	VDE 0482-1034-2, DIN EN 61034-2 (IEC 61034-2)
Gases evolved during combustion:	VDE 0482-267-2-2, DIN EN 50267-2-2(IEC 60754-2: pH ≥ 3,5; conductivity ≤ 100 μS cm ⁻¹)

CONSTRUCTION

Conductors:	bare solid copper conductor 0,6 and 0,8 mm
Insulation:	special halogen-free compound according to DIN EN 50290-2-26 (DIN VDE 0207-23)
Unit:	core twisted in quads and quads are stranded to units
Separator:	polyester tape
Screen:	aluminium/polyester laminated tape and solid copper drain wire
Drain wire:	solid tinned annealed copper wire 0,6 or 0,8 mm
Sheath:	thermoplastic halogen-free, flame retardant compound according to DIN EN 50290-27 (DIN VDE 0207-24)

CHARACTERISTIC

Colour of sheath: grey, orange or red

Colour code:	Quad no.	
	Quad 1:	basic colour of all cores red
	Quad 2:	basic colour of all cores green
	Quad 3:	basic colour of all cores grey
	Quad 4:	basic colour of all cores yellow
	Quad 5:	basic colour of all cores white

The insulation of single cores are marked with black rings – according to DIN VDE 0815

The marker of units are identified with a red plastic tape helix, the others units with white or uncoloured plastic tape.

Loop resistance: maximum 130 Ω/km at 0,6 mm,
73,2 Ω/km at 0,8 mm

Insulation resistance at temperature 20°C: minimum 100 MΩ x km

Mutual capacitance: maximum 120 nF/km1) at 800 Hz

Capacitance unbalance: K1 maximum 300 pF/100 m 2) at 800 Hz
K9 – K12 maximum 100 pF/100 m 3) at 800 Hz

Operating voltage (peak voltage): 300V (not for purposes of high current and power installations)

Temperature range: flexing: - 5°C to + 50°C; fixed installation- 30°C to + 70°C

Minimum bending radius: 6D (D - overall cable diameter)

FLAMEBLOCKER J-H(St)H ...Bd

Based on DIN VDE 0815

Application:	for signal transmission. The halogen-free installation cables with improved characteristics and produce no corrosive gases in case of fire are preferably used for indoor telecommunication installation in dry and damp places, but also in the open for fixed installation on outer walls of buildings.
Standard packing:	500 m on drums. Other forms of packing and delivery are available on request.

¹⁾ This value may be extended by 20% with make-up to 4 pairs

²⁾ 20% of the values, but one value up to 500 pF is allowed

³⁾ 10% of the values, but four values up to 300 pF are allowed

Number pairs and diameter of conductor	Approximate overall diameter	Approximate net weight of cable	Number pairs and diameter of conductor	Approximate overall diameter	Approximate net weight of cable
n x 2 x mm	mm	kg/km	n x 2 x mm	mm	kg/km
2 x 2 x 0,6	6,8	61	2 x 2 x 0,8	7,7	81
4 x 2 x 0,6	8,2	87	4 x 2 x 0,8	10,3	129
6 x 2 x 0,6	9,1	109	6 x 2 x 0,8	10,8	160
10 x 2 x 0,6	10,6	151	10 x 2 x 0,8	13,0	230
20 x 2 x 0,6	13,5	249	20 x 2 x 0,8	16,9	393
30 x 2 x 0,6	15,8	342	30 x 2 x 0,8	20,4	571
40 x 2 x 0,6	17,7	432	40 x 2 x 0,8	22,9	726
50 x 2 x 0,6	19,8	538	50 x 2 x 0,8	25,6	900
60 x 2 x 0,6	21,4	625	60 x 2 x 0,8	27,6	1051
80 x 2 x 0,6	24,1	797	80 x 2 x 0,8	31,6	1381
100 x 2 x 0,6	26,9	993	100 x 2 x 0,8	34,8	1678

Flexible halogen-free signal and control cable for electronics

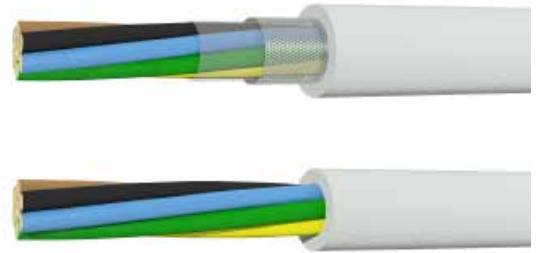

FIRE PERFORMANCE

Flame propagation:	EN 60332-1-2 (IEC 60332-1)
Smoke emission:	EN 61034-2 (IEC 61034-2)
Gases evolved during combustion:	EN 50267-2-1 (IEC 60754-1): < 0,5% acid gas EN 50267-2-2 (IEC 60754-2): pH ≥ 4,3; conductivity ≤ 10 µS/mm

CONSTRUCTION

LiHH	flexible, halogen-free insulated and sheathed, colour coded cables in multicore construction
LiHCH	flexible, halogen-free insulated, and sheathed colour coded cables in multicore construction, with collective screen
Conductor:	bare copper, fine wire conductors, bunch stranded
Insulation:	thermoplastic halogen-free compound type HI2
Assembly:	core twisted concentrically, LiHCH assembly foil taped
Screen:	tinned copper braid (only in LiHCH cables)
Sheath:	thermoplastic halogen-free compound type HM2

CHARACTERISTIC

Colour of sheath:	grey (RAL 7032)
Colour code:	1 to 10 cores – colour identification acc. to DIN 47100, 11 to 34 cores – insulation of the conductor gives the second colour extruded on the basic colour as a form of longitudinal stripes (according to special customer requirements - colour ring placed every 10 mm)

No of core	Colour	No of core	Colour	No of core	Colour	No of core	Colour	No of core	Colour
1	white	8	red	15	white-yellow	22	brown - blue	29	pink - green
2	brown	9	black	16	yellow - brown	23	white - red	30	yellow - pink
3	green	10	violet	17	white - grey	24	brown - red	31	green - blue
4	yellow	11	grey - pink	18	grey - brown	25	white - black	32	yellow - blue
5	grey	12	red - blue	19	white - pink	26	brown - black	33	green - red
6	pink	13	white - green	20	pink - brown	27	grey - green	34	yellow - red
7	blue	14	brown - green	21	white - blue	28	yellow - grey		

Peak working voltage:	500V (not for power purposes)
Inductance:	~0,7 mH /km
Mutual capacitance:	core – core ~ 120 nF/km, core – screen ~ 155 nF/km
Impedance:	~ 80Ω
Insulation resistance:	~ 200 MΩ x km

Maximum conductor resistance at temperature 20°C:	
0,50 mm ² (16 x 0,20 mm) ~ 39 Ω/km	1 mm ² (32 x 0,20 mm) ~ 19,5 Ω/km
0,75 mm ² (24 x 0,20 mm) ~ 26 Ω/km	1,5 mm ² (30 x 0,25 mm) ~ 13,3 Ω/km
Test voltage 50Hz:	1200V
Lowest ambient temperature for fixed installation:	-30°C do + 80°C
Lowest installation temperature:	-5°C
Minimum bending radius:	LiHH 7,5 x D, LiHCH 10 x D ; D – overall cable diameter
Application:	LiHH cables are data transmission cables also used in control and signal lines in electronics for computer systems, electronic control and regulating gear, office machinery, scales, etc. LiHCH cables are used in the electronics of computer systems, electronics control and regulating gear, office machinery, scales and anywhere where screened cables of the smallest dimensions are necessary. These cables having low emission of smoke and corrosive gases when exposed to fire.

Number of cores and conductor size	Thickness of insulation	LiHH			LiHCH			Number of cores and conductor size	Thickness of insulation	LiHH			LiHCH		
		Thickness of sheath	Approximate overall diameter	Size of screen wire	Thickness of sheath	Approximate overall diameter	Thickness of sheath			Approximate overall diameter	Size of screen wire	Thickness of sheath	Approximate overall diameter		
n x mm ²	mm	mm	mm	mm	mm	mm	n x mm ²	mm	mm	mm	mm	mm	mm	mm	
2 x 0,5	0,4	0,6	4,7	0,15	0,8	5,9	12 x 0,5	0,4	0,7	8,6	0,15	1,0	10,0		
2 x 0,75	0,4	0,6	5,2	0,15	0,8	6,4	12 x 0,75	0,4	0,7	9,7	0,15	1,0	11,1		
2 x 1	0,4	0,6	5,5	0,15	0,8	6,7	12 x 1	0,4	0,7	10,3	0,15	1,0	11,7		
2 x 1,5	0,5	0,6	6,4	0,15	1,0	8,0	12 x 1,5	0,5	0,8	12,4	0,20	1,0	13,9		
3 x 0,5	0,4	0,6	4,9	0,15	0,8	6,2	14 x 0,5	0,4	0,7	9,1	0,15	1,0	10,5		
3 x 0,75	0,4	0,6	5,5	0,15	0,8	6,7	14 x 0,75	0,4	0,7	10,2	0,15	1,0	11,6		
3 x 1	0,4	0,6	5,8	0,15	0,8	7,0	14 x 1	0,4	0,7	10,8	0,15	1,0	12,3		
3 x 1,5	0,5	0,6	6,8	0,15	1,0	8,4	14 x 1,5	0,5	0,8	13,1	0,20	1,0	14,5		
4 x 0,5	0,4	0,6	5,4	0,15	0,8	6,6	16 x 0,5	0,4	0,7	9,6	0,15	1,0	11,0		
4 x 0,75	0,4	0,6	6,0	0,15	0,8	7,2	16 x 0,75	0,4	0,7	10,8	0,15	1,0	12,2		
4 x 1	0,4	0,6	6,4	0,15	0,8	7,6	16 x 1	0,4	0,8	11,7	0,20	1,0	13,1		
4 x 1,5	0,5	0,7	7,7	0,15	1,0	9,1	16 x 1,5	0,5	0,8	13,8	0,20	1,2	15,7		
5 x 0,5	0,4	0,6	5,9	0,15	0,8	7,1	18 x 0,5	0,4	0,7	10,1	0,15	1,0	11,5		
5 x 0,75	0,4	0,6	6,6	0,15	1,0	8,2	18 x 0,75	0,4	0,8	11,6	0,20	1,0	13,0		
5 x 1	0,4	0,6	7,0	0,15	1,0	8,6	18 x 1	0,4	0,8	12,3	0,20	1,0	13,7		
5 x 1,5	0,5	0,7	8,4	0,15	1,0	9,8	18 x 1,5	0,5	1,0	15,0	0,20	1,2	16,5		
6 x 0,5	0,4	0,6	6,4	0,15	1,0	8,0	20 x 0,5	0,4	0,7	10,6	0,15	1,0	12,0		
6 x 0,75	0,4	0,7	7,4	0,15	1,0	8,8	20 x 0,75	0,4	0,8	12,2	0,20	1,0	13,6		
6 x 1	0,4	0,7	7,8	0,15	1,0	9,2	20 x 1	0,4	0,8	12,9	0,20	1,0	14,4		
6 x 1,5	0,5	0,7	9,2	0,15	1,0	10,6	20 x 1,5	0,5	1,0	15,8	0,20	1,2	17,2		
7 x 0,5	0,4	0,6	6,4	0,15	1,0	8,0	25 x 0,5	0,4	0,8	12,3	0,20	1,0	13,8		
7 x 0,75	0,4	0,7	7,4	0,15	1,0	8,8	25 x 0,75	0,4	0,8	13,9	0,20	1,2	15,8		
7 x 1	0,4	0,7	7,8	0,15	1,0	9,2	25 x 1	0,4	1,0	15,2	0,20	1,2	16,6		
7 x 1,5	0,5	0,7	9,2	0,15	1,0	10,6	25 x 1,5	0,5	1,2	18,4	0,20	1,4	19,9		
10 x 0,5	0,4	0,7	8,4	0,15	1,0	9,8	34 x 0,5	0,4	0,8	13,8	0,20	1,2	15,6		
10 x 0,75	0,4	0,7	9,4	0,15	1,0	10,8	34 x 0,75	0,4	1,0	16,0	0,20	1,4	17,8		
10 x 1	0,4	0,7	10,0	0,15	1,0	11,4	34 x 1	0,4	1,0	17,0	0,20	1,4	18,8		
10 x 1,5	0,5	0,8	12,0	0,20	1,0	13,5									

We bring the
safe energy



CHAPTER 4

FLAME-X 950 NKOGs 0,6/1 kV	136
FLAME-X 950 NKOGsekw 0,6/1 kV	139
FlameBlocker NKOXs 0,6/1 kV	142
FlameBlocker NKOXsekw 0,6/1 kV	145

Offshore/Marine Cables

Cables are manufactured with use of XLPE or special cross-linked HF S compound. All materials are halogen free, low smoke and have improved resistance for flame propagation. Selected types can also maintain its circuit integrity.

Application:

For fixed installations in all areas and open decks on ships

Tested and approved by:

ABS – American Bureau of Shipping
DNV – Det Norske Veritas
GL – Germanischer Lloyd AG
RINA – Rules for the Approval of Manufacturers of Materials
LR – Lloyd's Register
BV – Bureau Veritas
PRS – Polish Ships Register
RMRS – Russian Maritime Register of Shipping
ClassNK – Nippon Kaiji Kyokai (ship classification society)

Halogen-free fire resistant shipboard power cables



FIRE PERFORMANCE

Fire resistant:	IEC 60331-21: 3h, 750°C
Flame retardant:	IEC 60332-3-22 Category A/F for sizes < 35 mm ² IEC 60332-3-23 Category B/F for sizes > 35 mm ²
Smoke emission:	IEC 61034-2
Gases evolved during combustion:	IEC 60754-1: < 0,5% acid gas; IEC 60754-2: pH ≥ 4,3; conductivity ≤ 10 μSmm ⁻¹

CONSTRUCTION

Conductors:	circular or circular compacted stranded copper class 2 acc. to IEC 60228
Insulation:	special cross-linked compound HF S 95 acc. to IEC 60092-351
Inner covering:	special flame-retardant and halogen-free compound
Outer sheath:	thermoplastic halogen-free compound type SHF1 acc. to IEC 60092-359

CHARACTERISTIC

Colour of sheath: orange

Core identification:

	NKOGs	NKOGs zo
1-core:	not specified	green-yellow
2-core:	black, blue	—
3-core:	black, blue, brown	green-yellow, black, blue
4-core:	blue, brown, black, grey	green-yellow, black, blue, brown
5-core:	black, blue, brown, black, black	green-yellow, black, blue, brown, black
more 5-core:	in each layer: brown (starting core), blue (reference core), other cores natural	in outer layer: green-yellow, blue (reference core), others cores shall be natural, in other layers: brown (starting core), blue (reference core), other cores natural

Maximum conductor operating temperature: +90°C

Lowest ambient temperature for fixed installation: -40°C

Lowest installation temperature: -15°C

Maximum short-circuit conductor temperature: +250°C

Minimum bending radius:	Overall diameter of cable (D):	Minimum bending radius:
	≤ 25 mm	4 D
	> 25 mm	6 D

Application: for fixed installations in all areas and open deck in ships.

Number and cross-sectional area of conductor			Minimum number of wires in conductor	Nominal thickness of insulation	Nominal thickness of sheath	Overall diameter		Approximate net weight of cables	Maximum conductor resistance at 20°C
						min	max		
n x mm ²			n	mm	mm	mm		kg/km	W/km
1	x	1	7	1,0	1,0	4,9	6,1	39	18,1
1	x	1,5	7	1,0	1,0	5,2	6,5	46	12,1
1	x	2,5	7	1,0	1,0	5,5	6,9	58	7,41
1	x	4	7	1,0	1,1	6,2	7,7	80	4,61
1	x	6	7	1,0	1,1	6,7	8,3	99	3,08
1	x	10	7	1,0	1,1	7,6	9,3	143	1,83
1	x	16	19	1,0	1,1	8,5	10,5	204	1,15
1	x	25	19	1,2	1,2	10,0	12,5	310	0,727
1	x	35	19	1,2	1,2	11,0	14,0	405	0,524
1	x	50	19	1,4	1,3	13,0	16,0	546	0,387
1	x	70	19	1,4	1,4	14,5	18,0	752	0,268
1	x	95	19	1,6	1,4	16,5	20,5	1021	0,193
1	x	120	37	1,6	1,5	18,5	22,5	1264	0,153
1	x	150	37	1,8	1,6	20,5	24,5	1558	0,124
1	x	185	37	2,0	1,7	22,5	27,0	1933	0,0991
1	x	240	61	2,2	1,8	25,5	30,5	2497	0,0754
1	x	300	61	2,4	1,9	28,0	33,5	3104	0,0601
2	x	1	7	1,0	1,1	9,6	11,5	144	18,1
2	x	1,5	7	1,0	1,2	10,0	12,0	164	12,1
2	x	2,5	7	1,0	1,2	11,0	13,0	206	7,41
2	x	4	7	1,0	1,2	12,5	15,0	274	4,61
2	x	6	7	1,0	1,3	13,0	16,0	322	3,08
2	x	10	7	1,0	1,3	14,5	17,5	432	1,83
2	x	16	19	1,0	1,4	16,5	20,0	589	1,15
2	x	25	19	1,2	1,5	19,5	23,5	886	0,727
2	x	35	19	1,2	1,6	22,0	26,5	1162	0,524
2	x	50	19	1,4	1,7	26,0	31,0	1596	0,387
3	x	1	7	1,0	1,1	10,0	12,0	161	18,1
3	x	1,5	7	1,0	1,2	11,0	13,5	199	12,1
3	x	2,5	7	1,0	1,2	12,0	14,5	250	7,41
3	x	4	7	1,0	1,3	13,0	15,5	312	4,61
3	x	6	7	1,0	1,3	13,5	16,5	372	3,08
3	x	10	7	1,0	1,4	15,5	19,0	530	1,83
3	x	16	19	1,0	1,4	17,5	21,0	744	1,15
3	x	25	19	1,2	1,6	21,0	25,5	1124	0,727
3	x	35	19	1,2	1,7	24,0	28,5	1494	0,524
3	x	50	19	1,4	1,8	27,5	33,0	2032	0,387
3	x	70	19	1,4	2,0	31,5	37,5	2747	0,268
3	x	95	19	1,6	2,1	36,5	43,5	3787	0,193
3	x	120	37	1,6	2,2	40,0	47,5	4627	0,153
3	x	150	37	1,8	2,4	44,5	52,5	5762	0,124
3	x	185	37	2,0	2,6	49,0	58,5	7101	0,0991
3	x	240	61	2,2	2,8	56,0	65,5	9209	0,0754
4	x	1	7	1,0	1,2	11,0	13,0	192	18,1
4	x	1,5	7	1,0	1,2	12,0	14,5	236	12,1
4	x	2,5	7	1,0	1,2	13,0	15,5	295	7,41
4	x	4	7	1,0	1,3	13,5	16,5	368	4,61
4	x	6	7	1,0	1,3	15,0	18,0	462	3,08
4	x	10	7	1,0	1,4	17,5	21,0	677	1,83
4	x	16	19	1,0	1,5	19,0	23,0	924	1,15
4	x	25	19	1,2	1,7	24,5	29,5	1504	0,727

Number and cross-sectional area of conductor	Minimum number of wires in conductor	Nominal thickness of insulation	Nominal thickness of sheath	Overall diameter		Approximate net weight of cables	Maximum conductor resistance at 20°C
				min	max		
n x mm ²	n	mm	mm	mm		kg/km	W/km
4 x 50	19	1,4	1,9	30,5	36,5	2571	0,387
4 x 70	19	1,4	2,1	35,0	41,5	3495	0,268
4 x 95	19	1,6	2,3	40,5	48,5	4836	0,193
5 x 1	7	1,0	1,2	12,5	15,0	243	18,1
5 x 1,5	7	1,0	1,2	13,0	15,5	276	12,1
5 x 2,5	7	1,0	1,3	13,5	16,5	342	7,41
7 x 1	7	1,0	1,3	13,0	15,5	267	18,1
7 x 1,5	7	1,0	1,3	14,0	16,5	324	12,1
7 x 2,5	7	1,0	1,3	14,5	17,5	406	7,41
10 x 1	7	1,0	1,4	16,0	19,0	380	18,1
10 x 1,5	7	1,0	1,4	17,5	21,0	474	12,1
10 x 2,5	7	1,0	1,5	19,0	22,5	603	7,41
12 x 1	7	1,0	1,4	16,5	19,5	416	18,1
12 x 1,5	7	1,0	1,4	18,0	21,5	520	12,1
12 x 2,5	7	1,0	1,5	19,5	23,0	665	7,41
16 x 1	7	1,0	1,5	18,5	22,0	524	18,1
16 x 1,5	7	1,0	1,5	19,5	23,0	623	12,1
16 x 2,5	7	1,0	1,6	21,5	25,0	821	7,41
19 x 1	7	1,0	1,5	19,5	23,0	589	18,1
19 x 1,5	7	1,0	1,6	20,5	24,0	693	12,1
19 x 2,5	7	1,0	1,6	23,0	27,0	948	7,41
20 x 1	7	1,0	1,5	20,5	24,0	630	18,1
20 x 1,5	7	1,0	1,6	22,0	26,0	768	12,1
20 x 2,5	7	1,0	1,7	24,0	28,0	996	7,41
24 x 1	7	1,0	1,6	22,5	26,0	714	18,1
24 x 1,5	7	1,0	1,7	24,5	28,5	897	12,1
24 x 2,5	7	1,0	1,8	26,5	31,0	1184	7,41
27 x 1	7	1,0	1,6	23,0	26,5	769	18,1
27 x 1,5	7	1,0	1,7	25,0	29,0	964	12,1
27 x 2,5	7	1,0	1,8	27,0	31,5	1285	7,41
30 x 1	7	1,0	1,7	24,0	28,0	840	18,1
30 x 1,5	7	1,0	1,8	25,5	30,0	1049	12,1
30 x 2,5	7	1,0	1,9	28,0	33,0	1411	7,41
37 x 1	7	1,0	1,7	25,5	30,0	994	18,1
37 x 1,5	7	1,0	1,8	27,5	32,0	1232	12,1
37 x 2,5	7	1,0	2,0	30,5	35,5	1689	7,41

* Without approval certification



Halogen-free fire resistant shipboard power cables with screen

FIRE PERFORMANCE

Fire resistant:	IEC 60331-21: 3h, 750°C
Flame retardant:	IEC 60332-3-22 Category A/F for sizes < 35 mm ² IEC 60332-3-23 Category B/F for sizes > 35 mm ²
Smoke emission:	IEC 61034-2
Gases evolved during combustion:	IEC 60754-1: < 0,5% acid gas IEC 60754-2: pH ≥ 4,3; conductivity ≤ 10 μSmm ⁻¹

CONSTRUCTION

Conductors:	circular or circular compacted stranded copper class 2 acc. to IEC 60228
Insulation:	special cross-linked compound HF S 95 acc. to IEC 60092-351
Inner covering:	special flame-retardant and halogen-free compound
Screen:	copper wire braiding
Outer sheath:	thermoplastic halogen-free compound type SHF1 acc. to IEC 60092-359

CHARACTERISTIC

Colour of sheath:	orange	
Core identification:		
	NKOGsekw	NKOGsekw zo
1-core:	not specified	green-yellow
2-core:	black, blue	—
3-core:	black, blue, brown	green-yellow, black, blue
4-core:	blue, brown, black, grey	green-yellow, black, blue, brown
5-core:	black, blue, brown, black, black	green-yellow, black, blue, brown, black
more 5-core:	in each layer: brown (starting core), blue (reference core), other cores natural	in outer layer: green-yellow, blue (reference core), others cores shall be natural, in other layers: brown (starting core), blue (reference core), other cores natural
Maximum conductor operating temperature:	+90°C	
Lowest ambient temperature for fixed installation:	-40°C	
Lowest installation temperature:	-15°C	
Maximum short-circuit conductor temperature:	+250°C	
Minimum bending radius:	6 x D (D is the overall diameter of the cable)	
Application:	for fixed installations in all areas and open deck in ships.	

Number and cross-sectional area of conductor	Nominal thickness of insulation	Approximate thickness of inner covering	Nominal diameter of wire in the screen	Nominal thickness of sheath	Overall diameter		Approximate net weight of cables	
					Min.	Max.		
n x mm ²	mm	mm	mm	mm	mm		kg/km	
1 x 1	1,0	0,7	0,20	1,0	7,2	8,7	95	
1 x 1,5	1,0	0,7	0,20	1,1	7,7	9,2	107	
1 x 2,5	1,0	0,7	0,20	1,1	8,1	9,6	126	
1 x 4	1,0	0,7	0,20	1,1	8,5	10,5	145	
1 x 6	1,0	0,7	0,20	1,1	9,1	11,0	172	
1 x 10	1,0	0,7	0,20	1,1	10,0	12,0	224	
1 x 16	1,0	0,7	0,20	1,2	11,0	13,5	298	
1 x 25	1,2	0,9	0,20	1,2	13,0	15,5	428	
1 x 35	1,2	0,9	0,30	1,3	14,5	17,5	584	
1 x 50	1,4	0,9	0,30	1,4	16,5	19,5	751	
1 x 70	1,4	0,9	0,30	1,4	18,0	21,5	975	
1 x 95	1,6	0,9	0,30	1,5	20,0	24,0	1283	
1 x 120	1,6	0,9	0,30	1,6	22,0	26,0	1552	
1 x 150	1,8	0,9	0,30	1,6	23,5	28,0	1852	
1 x 185	2,0	0,9	0,30	1,7	25,5	30,5	2264	
1 x 240	2,2	0,9	0,30	1,8	28,5	34,0	2869	
1 x 300	2,4	0,9	0,30	1,9	31,5	37,0	3485	
2 x 1	1,0	0,7	0,20	1,2	10,5	13,0	196	
2 x 1,5	1,0	0,7	0,20	1,2	11,0	13,5	217	
2 x 2,5	1,0	0,7	0,20	1,2	12,0	14,5	264	
2 x 4	1,0	0,7	0,30	1,3	13,5	16,0	369	
2 x 6	1,0	0,7	0,30	1,3	14,5	17,5	419	
2 x 10	1,0	0,7	0,30	1,4	16,5	19,5	564	
2 x 16	1,0	0,7	0,30	1,5	18,5	22,0	752	
2 x 25	1,2	0,9	0,30	1,6	22,5	26,5	1101	
2 x 35	1,2	0,9	0,30	1,7	24,5	29,0	1372	
2 x 50	1,4	0,9	0,30	1,8	27,5	33,0	1814	
3 x 1	1,0	0,7	0,20	1,2	11,0	13,5	213	
3 x 1,5	1,0	0,7	0,20	1,2	11,5	14,0	242	
3 x 2,5	1,0	0,7	0,30	1,3	13,0	16,0	350	
3 x 4	1,0	0,7	0,30	1,3	14,0	17,0	414	
3 x 6	1,0	0,7	0,30	1,4	15,5	18,5	508	
3 x 10	1,0	0,7	0,30	1,4	17,5	20,5	681	
3 x 16	1,0	0,7	0,30	1,5	19,5	23,5	920	
3 x 25	1,2	0,9	0,30	1,6	23,5	28,0	1344	
3 x 35	1,2	0,9	0,30	1,7	26,0	31,0	1717	
3 x 50	1,4	0,9	0,30	1,9	29,5	35,0	2256	
3 x 70	1,4	1,1	0,30	2,0	33,5	40,0	3004	
3 x 95	1,6	1,1	0,40	2,2	39,0	46,5	4172	
3 x 120	1,6	1,1	0,40	2,3	42,0	50,0	5045	
3 x 150	1,8	1,3	0,40	2,5	47,0	55,0	6165	
3 x 185	2,0	1,3	0,40	2,7	51,5	61,0	7526	
3 x 240	2,2	1,4	0,40	2,9	58,0	68,0	9631	
4 x 1	1,0	0,7	0,20	1,2	12,0	14,0	249	
4 x 1,5	1,0	0,7	0,30	1,3	13,0	16,0	336	
4 x 2,5	1,0	0,7	0,30	1,3	14,0	17,0	392	
4 x 4	1,0	0,7	0,30	1,4	15,5	18,5	500	
4 x 6	1,0	0,7	0,30	1,4	17,0	20,0	586	
4 x 10	1,0	0,7	0,30	1,5	19,0	22,5	809	
4 x 16	1,0	0,7	0,30	1,6	21,5	25,5	1109	
4 x 25	1,2	0,9	0,30	1,7	26,0	30,5	1662	
4 x 35	1,2	0,9	0,30	1,8	28,5	34,0	2130	

Number and cross-sectional area of conductor	Nominal thickness of insulation	Approximate thickness of inner covering	Nominal diameter of wire in the screen	Nominal thickness of sheath	Overall diameter		Approximate net weight of cables
					Min.	Max.	
n x mm ²	mm	mm	mm	mm	mm		kg/km
5 x 1	1,0	0,7	0,30	1,3	13,5	16,0	336
5 x 1,5	1,0	0,7	0,30	1,3	14,0	17,0	377
5 x 2,5	1,0	0,7	0,30	1,4	15,5	18,5	474
7 x 1	1,0	0,7	0,30	1,3	14,5	17,0	376
7 x 1,5	1,0	0,7	0,30	1,3	15,0	18,0	446
7 x 2,5	1,0	0,7	0,30	1,4	16,5	19,5	545
9 x 1,5	1,0	0,7	0,30	1,5	18,5	21,5	570
10 x 1	1,0	0,7	0,30	1,4	17,5	20,5	522
10 x 1,5	1,0	0,7	0,30	1,5	19,0	22,0	604
10 x 2,5	1,0	0,7	0,30	1,5	20,5	24,0	756
12 x 1	1,0	0,7	0,30	1,5	18,5	21,5	567
12 x 1,5	1,0	0,7	0,30	1,5	19,5	23,0	671
12 x 2,5	1,0	0,7	0,30	1,6	21,0	25,0	853
14 x 1,5	1,0	0,7	0,30	1,5	20,5	24,0	727
16 x 1	1,0	0,7	0,30	1,5	20,0	23,5	682
16 x 1,5	1,0	0,7	0,30	1,6	21,5	25,0	821
16 x 2,5	1,0	0,7	0,30	1,7	23,5	27,5	1041
19 x 1	1,0	0,7	0,30	1,6	21,0	24,5	751
19 x 1,5	1,0	0,7	0,30	1,6	22,5	26,5	897
19 x 2,5	1,0	0,7	0,30	1,7	24,5	28,5	1176
20 x 1	1,0	0,7	0,30	1,6	22,0	26,0	806
20 x 1,5	1,0	0,7	0,30	1,7	24,0	27,5	963
20 x 2,5	1,0	0,7	0,30	1,8	26,0	30,5	1250
24 x 1	1,0	0,7	0,30	1,7	24,5	28,5	929
24 x 1,5	1,0	0,7	0,30	1,8	26,5	30,5	1131
24 x 2,5	1,0	0,7	0,30	1,9	28,5	33,5	1468
27 x 1	1,0	0,7	0,30	1,7	25,0	29,0	1013
27 x 1,5	1,0	0,7	0,30	1,8	27,0	31,0	1205
27 x 2,5	1,0	0,7	0,30	1,9	29,5	34,0	1571
30 x 1	1,0	0,7	0,30	1,7	25,5	30,0	1076
30 x 1,5	1,0	0,7	0,30	1,8	27,5	32,0	1313
30 x 2,5	1,0	0,7	0,30	1,9	30,0	35,0	1686
37 x 1	1,0	0,7	0,30	1,8	27,5	32,0	1265
37 x 1,5	1,0	0,7	0,30	1,9	30,0	34,5	1518
37 x 2,5	1,0	0,8	0,30	2,0	33,0	38,0	2013

FLAMEBLOCKER NKOXS 0,6/1 kV

IEC 60092-353

Halogen- free ship-board power cables with cross-linked polyethylene insulation and halogen-free sheath



FIRE PERFORMANCE

Flame retardant:	IEC 60332-3-22 Category A/F
Smoke emission:	IEC 61034-2
Gases evolved during combustion:	IEC 60754-1: < 0,5% acid gas IEC 60754-2: pH ≥ 4,3; conductivity ≤ 10 μSmm ⁻¹

CONSTRUCTION

Conductors:	circular or circular compacted stranded copper class 2 or class 5 acc. to IEC 60228*
Insulation:	cross-linked polyethylene HF XLPE 90oC, > 35 mm ² HF 90 acc. to IEC 60092-351
Separator:	tape optional
Inner covering:	special flame-retardant and halogen-free compound
Sheath:	thermoplastic halogen- free compound type SHF1 acc. to IEC 60092-359

CHARACTERISTIC

Colour of sheath: grey or black

Core identification:

	NKOXS	NKOXS žo
1-core:	not specified	green-yellow
2-core:	black, blue	—
3-core:	black, blue, brown	green-yellow, black, blue
4-core:	blue, brown, black, grey	green-yellow, black, blue, brown
5 and more:	white with black numbering	green-yellow, others cores white with black numbering

Maximum conductor operating temperature: +90°C

Lowest ambient temperature for fixed installation: -40°C

Lowest installation temperature: -15°C

Maximum short-circuit conductor temperature: +250°C

Minimum bending radius:	Overall diameter of cable (D)	Minimum bending radius
	≤ 25 mm	4 D
	> 25 mm	6 D

Application: For fixed installations in all areas and open deck in ships. Cables with class 5 conductors are produced on request.

Number and cross-sectional area of conductor	Minimum number of wires in conductor	Nominal thickness of insulation	Approximate thickness of inner covering	Nominal thickness of sheath	Overall diameter		Approximate net weight of cables	Maximum conductor resistance at 20°C	
					min	max			
n x mm ²	n	mm	mm	mm	mm		kg/km	W/km	
1 x 1	7	0,7	-	1,0	4,4	5,4	31	18,1	
1 x 1,5	7	0,7	-	1,0	4,7	5,8	38	12,1	
1 x 2,5	7	0,7	-	1,0	5,0	6,3	49	7,41	
1 x 4	7	0,7	-	1,0	5,4	6,9	66	4,61	
1 x 6	7	0,7	-	1,0	6,0	7,5	87	3,08	
1 x 10	7	0,7	-	1,1	7,0	8,7	132	1,83	
1 x 16	19	0,7	-	1,1	7,9	9,8	198	1,15	
1 x 25	19	0,9	-	1,2	9,7	12,0	306	0,727	
1 x 35	19	0,9	-	1,2	10,5	13,0	400	0,524	
1 x 50	19	1,0	-	1,3	12,0	15,0	536	0,387	
1 x 70	19	1,1	-	1,3	14,0	17,0	747	0,268	
1 x 95	19	1,1	-	1,4	16,0	19,5	1010	0,193	
1 x 120	37	1,2	-	1,5	17,5	21,5	1259	0,153	
1 x 150	37	1,4	-	1,5	19,5	23,5	1542	0,124	
1 x 185	37	1,6	-	1,6	21,5	26,0	1924	0,0991	
1 x 240	61	1,7	-	1,7	24,5	29,0	2487	0,0754	
1 x 300	61	1,8	-	1,8	27,0	32,0	3077	0,0601	
2 x 1	7	0,7	0,4	1,1	7,8	9,5	97	18,1	
2 x 1,5	7	0,7	0,4	1,1	8,3	10,5	116	12,1	
2 x 2,5	7	0,7	0,4	1,1	9,1	11,0	149	7,41	
2 x 4	7	0,7	0,4	1,2	10,0	12,5	201	4,61	
2 x 6	7	0,7	0,4	1,2	11,0	14,0	260	3,08	
2 x 10	7	0,7	0,4	1,3	13,0	16,0	382	1,83	
2 x 16	19	0,7	0,4	1,4	15,0	18,5	567	1,15	
2 x 25	19	0,9	0,4	1,5	18,5	22,5	867	0,727	
2 x 35	19	0,9	0,5	1,6	21,0	25,5	1140	0,524	
2 x 50	19	1,0	0,7	1,7	24,0	29,0	1503	0,387	
3 x 1	7	0,7	0,4	1,1	8,2	10,0	109	18,1	
3 x 1,5	7	0,7	0,4	1,1	8,8	11,0	133	12,1	
3 x 2,5	7	0,7	0,4	1,2	9,8	12,0	179	7,41	
3 x 4	7	0,7	0,4	1,2	10,5	13,0	239	4,61	
3 x 6	7	0,7	0,4	1,2	12,0	14,5	315	3,08	
3 x 10	7	0,7	0,4	1,3	14,0	17,0	470	1,83	
3 x 16	19	0,7	0,4	1,4	16,0	19,5	709	1,15	
3 x 25	19	0,9	0,4	1,5	19,5	24,0	1091	0,727	
3 x 35	19	0,9	0,6	1,6	22,5	27,0	1457	0,524	
3 x 50	19	1,0	0,6	1,7	25,5	30,5	1925	0,387	
3 x 70	19	1,1	0,8	1,9	30,0	36,0	2733	0,268	
3 x 95	19	1,1	0,8	2,0	34,0	41,0	3646	0,193	
3 x 120	37	1,2	0,8	2,2	38,0	45,0	4545	0,153	
3 x 150	37	1,4	1,4	2,3	43,0	51,0	5733	0,124	
3 x 185	37	1,6	1,4	2,5	48,0	57,0	7131	0,0991	
3 x 240	61	1,7	1,6	2,7	54,0	63,5	9217	0,0754	
4 x 1	7	0,7	0,4	1,1	8,8	11,0	127	18,1	
4 x 1,5	7	0,7	0,4	1,2	9,7	12,0	160	12,1	
4 x 2,5	7	0,7	0,4	1,2	10,5	13,0	213	7,41	
4 x 4	7	0,7	0,4	1,2	11,5	14,5	288	4,61	
4 x 6	7	0,7	0,4	1,3	13,0	16,0	391	3,08	
4 x 10	7	0,7	0,4	1,4	15,5	18,5	587	1,83	
4 x 16	19	0,7	0,4	1,5	18,0	21,5	890	1,15	
4 x 25	19	0,9	0,5	1,6	22,0	26,5	1383	0,727	

Number and cross-sectional area of conductor			Minimum number of wires in conductor	Nominal thickness of insulation	Approximate thickness of inner covering	Nominal thickness of sheath	Overall diameter		Approximate net weight of cables	Maximum conductor resistance at 20°C
							min	max		
n x mm ²			n	mm	mm	mm	mm		kg/km	W/km
4	x	50	19	1,0	0,8	1,8	28,5	34,5	2473	0,387
4	x	70	19	1,1	0,8	2,0	33,5	40,0	3470	0,268
4	x	95	19	1,1	1,0	2,2	38,0	46,0	4711	0,193
4	x	120	37	1,2	1,0	2,3	42,5	50,5	5835	0,153
4	x	150	37	1,4	1,2	2,5	47,5	56,0	7251	0,124
5	x	1	7	0,7	0,4	1,2	9,7	12,0	154	18,1
5	x	1,5	7	0,7	0,4	1,2	10,5	12,5	190	12,1
5	x	2,5	7	0,7	0,4	1,2	11,5	14,0	253	7,41
7	x	1	7	0,7	0,4	1,2	10,5	12,5	185	18,1
7	x	1,5	7	0,7	0,4	1,2	11,0	13,5	231	12,1
7	x	2,5	7	0,7	0,4	1,3	12,5	15,0	321	7,41
10	x	1	7	0,7	0,4	1,3	13,0	16,0	264	18,1
10	x	1,5	7	0,7	0,4	1,3	14,0	17,0	330	12,1
10	x	2,5	7	0,7	0,4	1,4	16,0	19,0	460	7,41
12	x	1	7	0,7	0,4	1,3	13,5	16,0	291	18,1
12	x	1,5	7	0,7	0,4	1,3	14,5	17,5	367	12,1
12	x	2,5	7	0,7	0,4	1,4	16,5	19,5	515	7,41
16	x	1	7	0,7	0,4	1,4	15,0	18,0	366	18,1
16	x	1,5	7	0,7	0,4	1,4	16,5	19,5	465	12,1
16	x	2,5	7	0,7	0,4	1,5	18,5	22,0	656	7,41
19	x	1	7	0,7	0,4	1,4	16,0	19,0	411	18,1
19	x	1,5	7	0,7	0,4	1,4	17,0	20,5	525	12,1
19	x	2,5	7	0,7	0,4	1,5	19,0	23,0	745	7,41
20	x	1	7	0,7	0,4	1,4	16,5	20,0	438	18,1
20	x	1,5	7	0,7	0,4	1,5	18,5	21,5	569	12,1
20	x	2,5	7	0,7	0,4	1,6	20,5	24,5	805	7,41
24	x	1	7	0,7	0,4	1,5	18,5	22,0	520	18,1
24	x	1,5	7	0,7	0,4	1,6	20,5	24,0	676	12,1
24	x	2,5	7	0,7	0,4	1,6	22,5	27,0	945	7,41
27	x	1	7	0,7	0,4	1,5	19,0	22,5	561	18,1
27	x	1,5	7	0,7	0,4	1,6	21,0	24,5	732	12,1
27	x	2,5	7	0,7	0,4	1,7	23,5	27,5	1042	7,41
30	x	1	7	0,7	0,4	1,5	19,5	23,0	607	18,1
30	x	1,5	7	0,7	0,4	1,6	21,5	25,5	795	12,1
30	x	2,5	7	0,7	0,4	1,7	24,0	28,5	1133	7,41
37	x	1	7	0,7	0,4	1,6	21,0	25,0	726	18,1
37	x	1,5	7	0,7	0,4	1,7	23,5	27,5	952	12,1
37	x	2,5	7	0,7	0,4	1,8	26,0	31,0	1364	7,41

FLAMEBLOCKER NKOXSekw 0,6/1 kV

IEC 60092-353



Halogen- free ship-board power cables with cross-linked polyethylene insulation and halogen-free sheath, with screen

FIRE PERFORMANCE

Flame retardant:	IEC 60332-3-22 Category A/F
Smoke emission:	IEC 61034-2
Gases evolved during combustion:	IEC 60754-1: < 0,5% acid gas IEC 60754-2: pH ≥ 4,3; conductivity ≤ 10 μSmm ⁻¹

CONSTRUCTION

Conductors:	circular or circular compacted stranded copper class 2 or class 5 acc. to IEC 60228*
Insulation:	cross-linked polyethylene HF XLPE 90°C, > 35 mm ² HF 90 acc. to IEC 60092-351
Separator:	tape optional
Inner covering:	special flame-retardant and halogen-free compound
Screen:	copper wire braiding
Sheath:	thermoplastic halogen- free compound type SHF1 acc. to IEC 60092-359

CHARACTERISTIC

Colour of sheath: grey or black

Core identification:

	NKOXS	NKOXS žo
1-core:	not specified	green-yellow
2-core:	black, blue	—
3-core:	black, blue, brown	green-yellow, black, blue
4-core:	blue, brown, black, grey	green-yellow, black, blue, brown
5 and more:	white with black numbering	green-yellow, others cores white with black numbering

Maximum conductor operating temperature: +90°C

Lowest ambient temperature for fixed installation: -40°C

Lowest installation temperature: -15°C

Maximum short-circuit conductor temperature: +250°C

Minimum bending radius:	Overall diameter of cable (D)	Minimum bending radius
	≤ 25 mm	4 D
	> 25 mm	6 D

Application: For fixed installations in all areas and open deck in ships.
*Cables with class 5 conductors are produced on request.

Number and cross-sectional area of conductor	Minimum number of wires in conductor	Nominal thickness of insulation	Approximate thickness of inner covering	Nominal diameter of wire in the screen	Nominal thickness of sheath	Overall diameter		Approximate net weight of cables	Maximum conductor resistance at 20°C	
						min	max			
n x mm ²	n	mm		mm	mm	mm		kg/km	W/km	
1 x 1	7	0,7	0,4	0,20	1,0	6,0	7,4	64	18,1	
1 x 1,5	7	0,7	0,4	0,20	1,0	6,3	7,7	76	12,1	
1 x 2,5	7	0,7	0,4	0,20	1,0	6,7	8,2	89	7,41	
1 x 4	7	0,7	0,4	0,20	1,1	7,4	9,0	115	4,61	
1 x 6	7	0,7	0,4	0,20	1,1	7,9	9,6	138	3,08	
1 x 10	7	0,7	0,4	0,20	1,1	8,7	10,5	186	1,83	
1 x 16	19	0,7	0,4	0,20	1,2	10,0	12,0	265	1,15	
1 x 25	19	0,9	0,4	0,20	1,2	11,5	14,0	384	0,727	
1 x 35	19	0,9	0,5	0,30	1,3	13,0	16,0	526	0,524	
1 x 50	19	1,0	0,5	0,30	1,3	14,5	17,5	677	0,387	
1 x 70	19	1,1	0,5	0,30	1,4	16,5	20,0	918	0,268	
1 x 95	19	1,1	0,5	0,30	1,5	18,5	22,5	1205	0,193	
1 x 120	37	1,2	0,6	0,30	1,5	20,0	24,5	1459	0,153	
1 x 150	37	1,4	0,7	0,30	1,6	22,5	26,5	1787	0,124	
1 x 185	37	1,6	0,8	0,30	1,7	25,0	29,5	2217	0,0991	
1 x 240	61	1,7	0,8	0,30	1,8	27,5	32,5	2818	0,0754	
1 x 300	61	1,8	0,8	0,30	1,9	30,0	35,5	3446	0,0601	
2 x 1	7	0,7	0,4	0,20	1,1	8,8	10,5	131	18,1	
2 x 1,5	7	0,7	0,4	0,20	1,1	9,3	11,5	154	12,1	
2 x 2,5	7	0,7	0,4	0,20	1,2	10,0	12,5	191	7,41	
2 x 4	7	0,7	0,4	0,20	1,2	11,0	13,5	242	4,61	
2 x 6	7	0,7	0,4	0,30	1,3	13,0	15,5	346	3,08	
2 x 10	7	0,7	0,4	0,30	1,3	14,5	17,5	475	1,83	
2 x 16	19	0,7	0,4	0,30	1,4	16,5	20,0	671	1,15	
2 x 25	19	0,9	0,5	0,30	1,5	20,0	24,0	987	0,727	
2 x 35	19	0,9	0,5	0,30	1,6	22,5	27,0	1259	0,524	
2 x 50	19	1,0	0,6	0,30	1,7	25,5	30,5	1641	0,387	
3 x 1	7	0,7	0,4	0,20	1,1	9,2	11,0	144	18,1	
3 x 1,5	7	0,7	0,4	0,20	1,2	10,0	12,0	177	12,1	
3 x 2,5	7	0,7	0,4	0,20	1,2	10,5	13,0	222	7,41	
3 x 4	7	0,7	0,4	0,20	1,2	11,5	14,5	289	4,61	
3 x 6	7	0,7	0,4	0,30	1,3	13,5	16,5	403	3,08	
3 x 10	7	0,7	0,4	0,30	1,4	15,5	19,0	573	1,83	
3 x 16	19	0,7	0,4	0,30	1,4	17,5	21,0	817	1,15	
3 x 25	19	0,9	0,5	0,30	1,6	21,5	26,0	1245	0,727	
3 x 35	19	0,9	0,5	0,30	1,7	24,0	28,5	1606	0,524	
3 x 50	19	1,0	0,6	0,30	1,8	27,0	32,5	2119	0,387	
3 x 70	19	1,1	0,6	0,30	2,0	31,5	37,5	2911	0,268	
3 x 95	19	1,1	0,7	0,40	2,1	36,0	43,0	3963	0,193	
3 x 120	37	1,2	0,8	0,40	2,3	40,0	47,5	4916	0,153	
3 x 150	37	1,4	1,4	0,40	2,4	45,0	53,0	6120	0,124	
3 x 185	37	1,6	1,4	0,40	2,6	50,0	59,0	7524	0,0991	
3 x 240	61	1,7	1,6	0,40	2,8	56,0	66,0	9640	0,0754	
4 x 1	7	0,7	0,4	0,20	1,2	10,0	12,0	172	18,1	
4 x 1,5	7	0,7	0,4	0,20	1,2	10,5	13,0	205	12,1	
4 x 2,5	7	0,7	0,4	0,20	1,2	11,5	14,0	261	7,41	
4 x 4	7	0,7	0,4	0,30	1,3	13,5	16,0	377	4,61	
4 x 6	7	0,7	0,4	0,30	1,3	14,5	17,5	489	3,08	
4 x 10	7	0,7	0,4	0,30	1,4	17,0	20,5	699	1,83	
4 x 16	19	0,7	0,4	0,30	1,5	19,5	23,0	1015	1,15	

Number and cross-sectional area of conductor	Minimum number of wires in conductor	Nominal thickness of insulation	Approximate thickness of inner covering	Nominal diameter of wire in the screen	Nominal thickness of sheath	Overall diameter		Approximate net weight of cables	Maximum conductor resistance at 20°C
						min	max		
n x mm ²	n	mm		mm	mm	mm		kg/km	W/km
4 x 35	19	0,9	0,5	0,30	1,8	26,5	31,5	2007	0,524
4 x 50	19	1,0	0,6	0,30	1,9	30,0	35,5	2661	0,387
4 x 70	19	1,1	0,6	0,40	2,1	35,0	42,0	3781	0,268
5 x 1	7	0,7	0,4	0,20	1,2	10,5	13,0	199	18,1
5 x 1,5	7	0,7	0,4	0,20	1,2	11,5	14,0	238	12,1
5 x 2,5	7	0,7	0,4	0,30	1,3	13,0	15,5	343	7,41
7 x 1	7	0,7	0,4	0,20	1,2	11,5	14,0	234	18,1
7 x 1,5	7	0,7	0,4	0,30	1,3	13,0	15,5	322	12,1
7 x 2,5	7	0,7	0,4	0,30	1,3	14,0	17,0	421	7,41
10 x 1	7	0,7	0,5	0,30	1,3	14,5	17,5	371	18,1
10 x 1,5	7	0,7	0,5	0,30	1,4	16,0	19,0	444	12,1
10 x 2,5	7	0,7	0,5	0,30	1,5	17,5	21,0	591	7,41
12 x 1	7	0,7	0,5	0,30	1,4	15,5	18,0	406	18,1
12 x 1,5	7	0,7	0,5	0,30	1,4	16,5	19,5	499	12,1
12 x 2,5	7	0,7	0,5	0,30	1,5	18,0	21,5	647	7,41
16 x 1	7	0,7	0,5	0,30	1,4	16,5	20,0	491	18,1
16 x 1,5	7	0,7	0,5	0,30	1,5	18,0	21,5	599	12,1
16 x 2,5	7	0,7	0,5	0,30	1,5	20,0	23,5	797	7,41
19 x 1	7	0,7	0,5	0,30	1,4	17,5	20,5	536	18,1
19 x 1,5	7	0,7	0,5	0,30	1,5	19,0	22,5	676	12,1
19 x 2,5	7	0,7	0,5	0,30	1,6	21,0	25,0	913	7,41
20 x 1	7	0,7	0,5	0,30	1,5	18,5	22,0	572	18,1
20 x 1,5	7	0,7	0,5	0,30	1,5	20,0	23,5	710	12,1
20 x 2,5	7	0,7	0,5	0,30	1,6	22,0	26,0	962	7,41
24 x 1	7	0,7	0,5	0,30	1,5	20,0	23,5	662	18,1
24 x 1,5	7	0,7	0,5	0,30	1,6	22,0	26,0	834	12,1
24 x 2,5	7	0,7	0,5	0,30	1,7	24,5	29,0	1139	7,41
27 x 1	7	0,7	0,5	0,30	1,6	20,5	24,5	713	18,1
27 x 1,5	7	0,7	0,5	0,30	1,6	22,5	26,5	891	12,1
27 x 2,5	7	0,7	0,5	0,30	1,7	25,0	29,5	1225	7,41
30 x 1	7	0,7	0,5	0,30	1,6	21,5	25,0	776	18,1
30 x 1,5	7	0,7	0,5	0,30	1,7	23,5	27,5	982	12,1
30 x 2,5	7	0,7	0,5	0,30	1,8	26,0	30,5	1329	7,41
37 x 1	7	0,7	0,5	0,30	1,6	23,0	27,0	885	18,1
37 x 1,5	7	0,7	0,5	0,30	1,7	25,0	29,5	1136	12,1
37 x 2,5	7	0,7	0,5	0,30	1,8	28,0	32,5	1572	7,41

DATA MATRIX

Construction

		CONDUCTOR							INSULATION							
		SOLID CLASS 1	STRANDED CLASS 2	STRANDED FLEX CLASS 5	STRANDED FLEX CLASS 6	ANNEALED	PLAIN	TINNED	MICA GLASS TAPE	EN 50363	B57655	DIN VDE 0207	DIN VDE 0276-604	DIN VDE 0266	IEC 60502-1	HD 603
FLAME-X 950	(N)HXH FE180/E30	X	X			X	X							HX11		
FLAME-X 950	(N)HXH FE180/E90	X	X			X	X							HX11		
FLAME-X 950	NHXH FE180/E30	X	X			X	X		X					HX11		
FLAME-X 950	NHXH FE180/E90	X	X			X	X		X					HX11		
FLAME-X 950	(N)HXCH FE180/E30	X	X			X	X							HX11		
FLAME-X 950	(N)HXCH FE180/E90	X	X			X	X							HX11		
FLAME-X 950	NHXCH FE180/E30	X	X			X	X		X					HX11		
FLAME-X 950	NHXCH FE180/E90	X	X			X	X		X					HX11		
FLAME-X 950	Standard	X	X			X	X			EI2						
FLAME-X 950	Enhanced	X	X			X	X		X	EI2						
FLAME-X 950	Power		X			X	X		X		GP8					
FLAME-X 950	Single		X			X	X		X	EI5						
FLAME-X 950	FR Flex 3013			X		X	X	X	X							
FLAME-X 950	CR-1 C1	X	X			X	X			EI2						
FLAME-X 950	HDGs	X				X	X			EI2						
FLAME-X 950	HLGs		X			X	X			EI2						
FLAME-X 950	HLgGs			X		X	X			EI2						
FLAME-X 950	HDGsekw	X				X	X			EI2						
FLAME-X 950	HLGsekw		X			X	X			EI2						
FLAME-X 950	HLgGsekw			X		X	X			EI2						
FlameBlocker	N2XH	X	X			X	X						2XI1			
FlameBlocker	(N)2XH FE180	X	X			X	X		X				2XI1			
FlameBlocker	N2XCH	X	X			X	X						2XI1			
FlameBlocker	(N)2XCH FE180	X	X			X	X		X				2XI1			
FlameBlocker	NHXMH 300/500V	X	X			X	X						2XI1			
FlameBlocker	(N)HXMH(St)	X	X			X	X						2XI1			
FlameBlocker	H07Z-K			X		X				EI5						
FlameBlocker	H07Z-U	X				X				EI5						
FlameBlocker	H07Z-R		X			X				EI5						
FlameBlocker	H07ZZ-F			X		X	X	X		EI8						
FlameBlocker	H05Z1Z1-F			X		X	X			TI6						
FlameBlocker	6181B 450/750V	X	X			X	X			EI5						
FlameBlocker	6181XB 600/1000V	X	X			X	X				GP8					
FlameBlocker	624B*	X	X			X	X				GP8					
FlameBlocker	318B*			X		X	X			TI6						
FlameBlocker	FR-N1X1G1 0,6/1kV	X	X			X	X								XLPE	
FlameBlocker	Cu/XLPE/LSOH/AWA/LSOH 0,6/1 kV		X			X	X				GP8					
FlameBlocker	Cu/XLPE/LSOH/SWA/LSOH 0,6/1 kV		X			X	X				GP8					
FlameBlocker	FR-N1 X1G1Z4	X	X			X	X								XLPE	
FlameBlocker	MMJ HF 450/750V	X	X			X	X					HI2				
FlameBlocker	EQQ Light 300/500V	X				X	X					HI2				
FlameBlocker	EXQJ 0,6/1 kV	X				X	X									DIX3
FlameBlocker	FXQJ 0,6/1 kV		X			X	X									DIX3
FlameBlocker	AXQJ 0,6/1 kV		X													DIX3
FlameBlocker	NSHXAFÖU 1,8/3 kV			X		X		X				3GI3				
FlameBlocker	NSHXAFÖU 3,6/6 kV			X		X		X				3GI3				
Flame-X 950	JE-H(St)H ... Bd FE180/E90	X				X	X		X				HI1			
FlameBlocker	JE-H(St)H ... Bd	X				X	X						HI2			
FlameBlocker	J-H(St)H ... Bd	X				X	X						HI2			
FlameBlocker	LiHH			X		X	X						HI2			
FlameBlocker	LiHCH			X		X	X						HI2			
Flame-X 950	NKOGs 1kV		X	X		X	X	X								
Flame-X 950	NKOGsekw 1kV		X	X		X	X	X								
FlameBlocker	NKOXs 1kV		X	X		X	X	X								
FlameBlocker	NKOXsekw 1kV		X	X		X	X	X								

		INSULATION		OUTER SHEATH								MAX TEMP	
		IEC 60092-351	AS/NZS 3808	AS/NZS 3808	EN 50363	BS 7655	ZN-TF-208	DIN VDE 0207	IEC 60502-1	IEC 60092-359	DIN VDE 0276-604	DIN VDE 0250-214	
FLAME-X 950	(N)HXH FE180/E30										HM4		90
FLAME-X 950	(N)HXH FE180/E90										HM4		90
FLAME-X 950	NHXH FE180/E30										HM4		90
FLAME-X 950	NHXH FE180/E90										HM4		90
FLAME-X 950	(N)HXCH FE180/E30										HM4		90
FLAME-X 950	(N)HXCH FE180/E90										HM4		90
FLAME-X 950	NHXCH FE180/E30										HM4		90
FLAME-X 950	NHXCH FE180/E90										HM4		90
FLAME-X 950	Standard					LTS3							90
FLAME-X 950	Enhanced					LTS3							90
FLAME-X 950	Power					LTS1							90
FLAME-X 950	Single												90
FLAME-X 950	FR Flex 3013		X-HF-110	HFS-110-TP									110
FLAME-X 950	CR-1 C1										HM4		90
FLAME-X 950	HDGs						X			SHF1			90
FLAME-X 950	HLGs						X			SHF1			90
FLAME-X 950	HLgGs						X			SHF1			90
FLAME-X 950	HDGsekw						X			SHF1			90
FLAME-X 950	HLGsekw						X			SHF1			90
FLAME-X 950	HLgGsekw						X			SHF1			90
FlameBlocker	N2XH							HM4			HM4		90
FlameBlocker	(N)2XH FE180								ST8				90
FlameBlocker	N2XCH							HM4			HM4		90
FlameBlocker	(N)2XCH FE180								ST8				90
FlameBlocker	NHXMH 300/500V							HM2			HM2		70
FlameBlocker	(N)HXMH(St)							HM2			HM2		70
FlameBlocker	H07Z-K												90
FlameBlocker	H07Z-U												90
FlameBlocker	H07Z-R												90
FlameBlocker	H07ZZ-F				EM8								70
FlameBlocker	H05Z1Z1-F				TM7								70
FlameBlocker	6181B 450/750V					LTS4							90
FlameBlocker	6181XB 600/1000V					LTS1							90
FlameBlocker	624B*					LTS2							90
FlameBlocker	318B*				TM7								60
FlameBlocker	FR-N1X1G1 0,6/1kV								ST8				90
FlameBlocker	Cu/XLPE/LSOH/AWA/LSOH 0,6/1 kV					LTS1							90
FlameBlocker	Cu/XLPE/LSOH/SWA/LSOH 0,6/1 kV					LTS1							90
FlameBlocker	FR-N1 X1G1Z4								ST8				90
FlameBlocker	MMJ HF 450/750V							HM2					70
FlameBlocker	EQQ Light 300/500V							HM2					70
FlameBlocker	EXQJ 0,6/1 kV										HM4		90
FlameBlocker	FXQJ 0,6/1 kV										HM4		90
FlameBlocker	AXQJ 0,6/1 kV										HM4		90
FlameBlocker	NSHXAFÖU 1,8/3 kV							HM3					90
FlameBlocker	NSHXAFÖU 3,6/6 kV							HM3					90
Flame-X 950	JE-H(St)H ... Bd FE180/E90							HM2					70
FlameBlocker	JE-H(St)H ... Bd							HM2					70
FlameBlocker	J-H(St)H ... Bd							HM2					70
FlameBlocker	LiHH							HM2					80
FlameBlocker	LiHCH							HM2					80
Flame-X 950	NKOGs 1kV	HF S 95							SHF1				90
Flame-X 950	NKOGsekw 1kV	HF S 95							SHF1				90
FlameBlocker	NKOXs 1kV	HF XLPE/ HF 90							SHF1				90
FlameBlocker	NKOXsekw 1kV	HF XLPE/ HF 90							SHF1				90

DATA MATRIX

Fire performance

		System Circuit Integrity		Cable Circuit Integrity												Flame Spread (Single)						
		DIN 4102-12	AS/NZS 3013	IEC 60331-21	IEC 60331-23	IEC 60331-25	IEC 60331-31	EN 50200	EN 50362	BS 8434-1	BS 5839	BS 8434-2	BS 6387 CWZ	BS 7846	DIN VDE 0472-814	NFC C 32-070	AS/NZS 1660.5.5.4	UL 2196	IEC 60332-1-2	EN 60332-1-2	VDE 0482-332-1-1	AS/NZS 1660.5.6.3
FLAME-X 950	(N)HXH FE180/E30	X		X											X		X		X	X	X	X
FLAME-X 950	(N)HXH FE180/E90	X		X											X		X		X	X	X	X
FLAME-X 950	NHXH FE180/E30	X		X											X		X		X	X	X	X
FLAME-X 950	NHXH FE180/E90	X		X											X		X		X	X	X	X
FLAME-X 950	(N)HXCH FE180/E30	X		X											X		X		X	X	X	X
FLAME-X 950	(N)HXCH FE180/E90	X		X											X		X		X	X	X	X
FLAME-X 950	NHXCH FE180/E30	X		X											X		X		X	x	x	X
FLAME-X 950	NHXCH FE180/E90	X		X											X		X		X	x	x	X
FLAME-X 950	Standard	X		X				X		X	X	X	X		X				X	X	X	X
FLAME-X 950	Enhanced	X		X				X		X	X	X	X		X				X	X	X	X
FLAME-X 950	Power			X									X	X					X	X	X	X
FLAME-X 950	Single			X									X						X	X	X	X
FLAME-X 950	FR Flex 3013		X	X				X					X		X		X		X	x	x	X
FLAME-X 950	CR-1 C1			X				X								X			X	X	X	X
FLAME-X 950	HDGs			X				X					X		X		X		X	X	X	X
FLAME-X 950	HLGs			X				X					X		X		X		X	X	X	X
FLAME-X 950	HLgGs			X				X					X		X		X		X	X	X	X
FLAME-X 950	HDGsekw			X				X					X		X		X		X	X	X	X
FLAME-X 950	HLGsekw			X				X					X		X		X		X	X	X	X
FLAME-X 950	HLgGsekw			X				X					X		X		X		X	X	X	X
FlameBlocker	N2XH																		X	X	X	X
FlameBlocker	(N)2XH FE180			X											X		X		X	X	X	X
FlameBlocker	N2XCH																		X	X	X	X
FlameBlocker	(N)2XCH FE180			X											X		X		X	X	X	x
FlameBlocker	NHXMH 300/500V																		X	X	X	X
FlameBlocker	(N)HXMH(St)																		X	X	X	X
FlameBlocker	H07Z-K																		X	X	X	X
FlameBlocker	H07Z-U																		X	X	X	X
FlameBlocker	H07Z-R																		X	X	X	X
FlameBlocker	H07ZZ-F																		X	X	X	X
FlameBlocker	H05Z1Z1-F																		X	X	X	X
FlameBlocker	6181B 450/750V																		X	X	X	X
FlameBlocker	6181XB 600/1000V																		X	X	X	X
FlameBlocker	624B*																		X	X	X	X
FlameBlocker	318B*																		X	X	X	X
FlameBlocker	FR-N1X1G1 0,6/1kV																		X	X	X	X
FlameBlocker	Cu/XLPE/LSOH/AWA/LSOH 0,6/1 kV																		X	X	X	X
FlameBlocker	Cu/XLPE/LSOH/SWA/LSOH 0,6/1 kV																		X	X	X	X
FlameBlocker	FR-N1 X1G1Z4																		X	X	X	X
FlameBlocker	MMJ HF 450/750V																		X	X	X	X
FlameBlocker	EQQ Light 300/500V																		X	X	X	X
FlameBlocker	EXQJ 0,6/1 kV																					
FlameBlocker	FXQJ 0,6/1 kV																		X	X	X	X
FlameBlocker	AXQJ 0,6/1 kV																		X	X	X	X
FlameBlocker	NSHXAFÖU 1,8/3 kV																		X	X	X	X
FlameBlocker	NSHXAFÖU 3,6/6 kV																		X	X	X	X
Flame-X 950	JE-H(St)H ... Bd FE180/E90	X			X			X							X		X		X	X	X	X
FlameBlocker	JE-H(St)H ... Bd																		X	X	X	X
FlameBlocker	J-H(St)H ... Bd																		X	X	X	X
FlameBlocker	LiHH																		X	X	X	X
FlameBlocker	LiHCH																		X	X	X	X
Flame-X 950	NKOGs 1kV			X			X	X							X		X		X	X	X	X
Flame-X 950	NKOGsekw 1kV			X			X	X							X		X		X	X	X	X
FlameBlocker	NKOGs 1kV																		X	X	X	X
FlameBlocker	NKOGsekw 1kV																		X	X	X	X

		Flame Spread (Bunched)											Smoke Emission				Corrosive and Acid Gas Emission										
		IEC 60332-3-22	IEC 60332-3-23	IEC 60332-3-24	IEC 60332-3-25	EN 50266-2-2	EN 50266-2-3	EN 50266-2-4	EN 50266-2-5	VDE 0482-266-2-2	VDE 0482-266-2-3	VDE 0482-266-2-4	NF C 32-070	AS/NZS 1660.5.1.4	AS/NZS 1660.5.1.6	IEC 61034-2	EN 61034-2	VDE 0482-1034-2	AS/NZS 1660.5.2	IEC 60754-2-1	IEC 60754-2-2	EN 50267-2-1	EN 50267-2-2	VDE 0482-267-2-1	VDE 0482-267-2-2	AS/NZS 1660.5.3	AS/NZS 1660.5.4
FLAME-X 950	(N)HXH FE180/E30	X		X		X		X		X		X	X	X	X	X	X	X	X	X	X	X	X	X	X	X	X
FLAME-X 950	(N)HXH FE180/E90	X		X		X		X		X		X	X	X	X	X	X	X	X	X	X	X	X	X	X	X	X
FLAME-X 950	NHXH FE180/E30	X		X		X		X		X		X	X	X	X	X	X	X	X	X	X	X	X	X	X	X	X
FLAME-X 950	NHXH FE180/E90	X		X		X		X		X		X	X	X	X	X	X	X	X	X	X	X	X	X	X	X	X
FLAME-X 950	(N)HXCH FE180/E30	X		X		X		X		X		X	X	X	X	X	X	X	X	X	X	X	X	X	X	X	X
FLAME-X 950	(N)HXCH FE180/E90	X		X		X		X		X		X	X	X	X	X	X	X	X	X	X	X	X	X	X	X	X
FLAME-X 950	NHXCH FE180/E30	X		X		X		X		X		X	X	X	X	X	X	X	X	X	X	X	X	X	X	X	X
FLAME-X 950	NHXCH FE180/E90	X		X		X		X		X		X	X	X	X	X	X	X	X	X	X	X	X	X	X	X	X
FLAME-X 950	Standard	X		X		X		X		X		X	X	X	X	X	X	X	X	X	X	X	X	X	X	X	X
FLAME-X 950	Enhanced	X		X		X		X		X		X	X	X	X	X	X	X	X	X	X	X	X	X	X	X	X
FLAME-X 950	Power		X					X						X	X	X	X	X	X	X	X	X	X	X	X	X	X
FLAME-X 950	Single														X	X	X	X	X	X	X	X	X	X	X	X	X
FLAME-X 950	FR Flex 3013	X		X		X		X		X		X	X	X	X	X	X	X	X	X	X	X	X	X	X	X	X
FLAME-X 950	CR-1 C1	X		X		X		X		X	X	X	X	X	X	X	X	X	X	X	X	X	X	X	X	X	X
FLAME-X 950	HDGs	X		X		X		X		X		X	X	X	X	X	X	X	X	X	X	X	X	X	X	X	X
FLAME-X 950	HLGs	X		X		X		X		X		X	X	X	X	X	X	X	X	X	X	X	X	X	X	X	X
FLAME-X 950	HLgGs	X		X		X		X		X		X	X	X	X	X	X	X	X	X	X	X	X	X	X	X	X
FLAME-X 950	HDGsekw	X		X		X		X		X		X	X	X	X	X	X	X	X	X	X	X	X	X	X	X	X
FLAME-X 950	HLGsekw	X		X		X		X		X		X	X	X	X	X	X	X	X	X	X	X	X	X	X	X	X
FLAME-X 950	HLGsekw	X		X		X		X		X		X	X	X	X	X	X	X	X	X	X	X	X	X	X	X	X
FlameBlocker	N2XH			X				X						X	X	X	X	X	X	X	X	X	X	X	X	X	X
FlameBlocker	(N)2XH FE180			X				X						X	X	X	X	X	X	X	X	X	X	X	X	X	X
FlameBlocker	N2XCH			X				X						X	X	X	X	X	X	X	X	X	X	X	X	X	X
FlameBlocker	(N)2XCH FE180			X				X						X	X	X	X	X	X	X	X	X	X	X	X	X	X
FlameBlocker	NHXMH 300/500V			X				X						X	X	X	X	X	X	X	X	X	X	X	X	X	X
FlameBlocker	(N)HXMH(St)			X				X						X	X	X	X	X	X	X	X	X	X	X	X	X	X
FlameBlocker	H07Z-K														X	X	X	X	X	X	X	X	X	X	X	X	X
FlameBlocker	H07Z-U														X	X	X	X	X	X	X	X	X	X	X	X	X
FlameBlocker	H07Z-R														X	X	X	X	X	X	X	X	X	X	X	X	X
FlameBlocker	H07ZZ-F			X				X						X	X	X	X	X	X	X	X	X	X	X	X	X	X
FlameBlocker	H05Z1Z1-F														X	X	X	X	X	X	X	X	X	X	X	X	X
FlameBlocker	6181B 450/750V														X	X	X	X	X	X	X	X	X	X	X	X	X
FlameBlocker	6181XB 600/1000V														X	X	X	X	X	X	X	X	X	X	X	X	X
FlameBlocker	624B*														X	X	X	X	X	X	X	X	X	X	X	X	X
FlameBlocker	318B*														X	X	X	X	X	X	X	X	X	X	X	X	X
FlameBlocker	FR-N1X1G1 0,6/1kV			X				X						X	X	X	X	X	X	X	X	X	X	X	X	X	X
FlameBlocker	Cu/XLPE/LSOH/AWA/LSOH 0,6/1 kV			X				X						X	X	X	X	X	X	X	X	X	X	X	X	X	X
FlameBlocker	Cu/XLPE/LSOH/SWA/LSOH 0,6/1 kV			X				X						X	X	X	X	X	X	X	X	X	X	X	X	X	X
FlameBlocker	FR-N1 X1G1Z4			X				X						X	X	X	X	X	X	X	X	X	X	X	X	X	X
FlameBlocker	MMJ HF 450/750V		X					X							X	X	X	X	X	X	X	X	X	X	X	X	X
FlameBlocker	EQQ Light 300/500V														X	X	X	X	X	X	X	X	X	X	X	X	X
FlameBlocker	EXQJ 0,6/1 kV			X				X						X	X	X	X	X	X	X	X	X	X	X	X	X	X
FlameBlocker	FXQJ 0,6/1 kV			X				X						X	X	X	X	X	X	X	X	X	X	X	X	X	X
FlameBlocker	AXQJ 0,6/1 kV			X				X						X	X	X	X	X	X	X	X	X	X	X	X	X	X
FlameBlocker	NSHXAFÖU 1,8/3 kV														X	X	X	X	X	X	X	X	X	X	X	X	X
FlameBlocker	NSHXAFÖU 3,6/6 kV														X	X	X	X	X	X	X	X	X	X	X	X	X
Flame-X 950	JE-H(St)H ... Bd FE180/E90			X				X						X	X	X	X	X	X	X	X	X	X	X	X	X	X
FlameBlocker	JE-H(St)H ... Bd			X				X						X	X	X	X	X	X	X	X	X	X	X	X	X	X
FlameBlocker	J-H(St)H ... Bd			X				X						X	X	X	X	X	X	X	X	X	X	X	X	X	X
FlameBlocker	LiHH														X	X	X	X	X	X	X	X	X	X	X	X	X
FlameBlocker	LiHCH														X	X	X	X	X	X	X	X	X	X	X	X	X
Flame-X 950	NKOGs 1kV	X	X	X		X	X	X		X	X	X	X	X	X	X	X	X	X	X	X	X	X	X	X	X	X
Flame-X 950	NKOGsekw 1kV	X	X	X		X	X	X		X	X	X	X	X	X	X	X	X	X	X	X	X	X	X	X	X	X
FlameBlocker	NKOGs 1kV	X	X	X		X	X	X		X	X	X	X	X	X	X	X	X	X	X	X	X	X	X	X	X	X
FlameBlocker	NKOGsekw 1kV	X	X	X		X	X	X		X	X	X	X	X	X	X	X	X	X	X	X	X	X	X	X	X	X

NOTES



NOTES

TELE-FONIKA Kable cannot be held responsible for any printing errors, and reserves the right to change the contents of the information without prior notice.

All Rights Reserved – TELE-FONIKA Kable Sp. z o.o. S.K.A.

Edition II



TELE-FONIKA Kable Sp. z o.o. S.K.A.

Wielicka Street No. 114, 30-663 Cracow

T: (+48) 12 652 51 02, (+48) 12 652 59 31, (+48) 12 652 59 37

F: (+48) 12 652 59 28

export@tfkable.pl

www.tfkable.com

